



LISTINO 2019



LINEA
GASTROLABOR



LINEA
RETROBAR



LINEA
CARNI



LINEA
CAPPE

INDICE

LINEA GASTROLABOR

TAVOLI DA LAVORO

Tavolo su telaio	8
Tavolo su telaio con alzatina	10
Tavolo con sottopiano	12
Tavolo con sottopiano e alzatina	14
Tavolo con 2 ripiani	16
Tavolo con 2 ripiani e alzatina	18
Tavolo armadiato a giorno con ripiano intermedio	20
Tavolo armadiato a giorno con ripiano intermedio e alzatina	22
Tavolo armadiato con ante scorrevoli e ripiano intermedio	24
Tavolo armadiato con ante scorrevoli, ripiano intermedio e alzatina	26
Tavolo armadiato con ante scorrevoli su 2 lati	28
Tavolo armadiato con ante a battente e ripiano intermedio	31
Tavolo armadiato con ante a battente, ripiano intermedio e alzatina	31
Tavolo armadiato con ante scorrevoli e cassetiera verticale	33
Tavolo armadiato con ante a battente e cassetiera verticale	33
Tavolo armadiato con ante scorrevoli, cassetiera verticale e alzatina	35
Tavolo armadiato con ante a battente, cassetiera verticale e alzatina	35
Tavolo armadiato con ante scorrevoli, cassetiera orizzontale	37
Tavolo armadiato con ante scorrevoli, cassetiera orizzontale e alzatina	39
Tavolo armadiato con ante a battente, cassetiera orizzontale	41
Tavolo armadiato con ante a battente, cassetiera orizzontale e alzatina	41

Accessori tavoli da lavoro

Ripiano d'appoggio.....	43
Cassettiere	43
Top	46
Top con alzatina	48
Ripiano intermedio	50
Lavorazioni speciali	52

PENSILI & MENSOLE

Pensile a giorno con ripiano	56
Pensile a giorno con ripiano scolapiatti e ripiano asolato	58
Pensile con ante a battente e ripiano	60
Pensile con ante scorrevoli e ripiano	60
Pensile con ante a battente, scolapiatti e ripiano asolato	62
Pensile con ante scorrevoli, scolapiatti e ripiano asolato	62
Pensile con ante scorrevoli e ripiani asolati	64
Mensole con reggimensole saldate	66
Mensole con staffa integrata	68

SCAFFALI & ARMADI

Scaffale aperto con ripiani lisci	70
Scaffale aperto con ripiani asolati	72
Armadio con ante a battente	74
Armadio con ante scorrevoli	75
Armadi sovrapposti con ante scorrevoli e ripiano intermedio	76

LAVELLI

Lavello a giorno	78
Lavello a giorno con ripiano	82
Lavello armadiato con ante scorrevoli	86
Lavello armadiato con ante a battente	90
Lavello lavastoviglie con ripiano	92
Lavello lavastoviglie armadiato con ante a battente	94
Lavello lavastoviglie armadiato con ante scorrevoli	95
Lavapentole	96
Tavolo prelavaggio	97
Tavolo uscita lavastoviglie	98
Tavoli preparazione carne/pesce	98
Tavolo sbarazzo e lavaggio stoviglie	99

Accessori lavelli

Griglia e falsofondo forato	100
-----------------------------------	-----

LINEA RETROBAR

TAVOLI ARMADIATI

Tavolo armadiato a giorno	102
Tavolo armadiato a giorno con alzatina	104
Tavolo armadiato a giorno con ripiano	106
Tavolo armadiato a giorno con ripiano e alzatina	108
Tavolo armadiato con ante scorrevoli	110
Tavolo armadiato con ante scorrevoli e alzatina	112
Tavolo armadiato con ante scorrevoli e cassetiera 3 cassetti	114
Tavolo armadiato con ante scorrevoli, cassetiera 3 cassetti e alzatina	116
Tavolo armadiato con ante a battente	118
Tavolo armadiato con ante a battente e alzatina	118
Tavolo armadiato con ante a battente e cassetiera 3 cassetti	120
Tavolo armadiato con ante a battente, cassetiera 3 cassetti e alzatina	120

RETRO MACCHINE CAFFÈ

Retro bar Macchina caffè	122
Retro basi Macchina caffè	124

LINEA CARNI

Carrelli portasalumi	128
----------------------------	-----

LINEA CAPPE

CAPPE SENZA MOTORE

Cappa Snack a parete	132
Cappa Snack centrale	134
Cappa a parete	136
Cappa centrale	138
Cappa cubica a parete	140
Cappa cubica centrale	142
Cappa vapor	144

CAPPE CON MOTORE

Cappa Snack a parete	148
Cappa Snack centrale	150
Cappa a parete	152
Cappa centrale	154
Cappa cubica a parete	156
Cappa cubica centrale	158
Cappa vapor	160

ACCESSORI CAPPE	162
-----------------------	-----

VENTILAZIONE	165
--------------------	-----

TAVOLI DA LAVORO



- Struttura in acciaio inox AISI 304 18/10 scotch brite anticorrosione e antitaglio;
- Gambe con tubolare quadro 40 x 40 scotch brite con piedini regolabili;
- Accessori a richiesta: cassetti, cassetiera, alzatine speciali, ruote etc.;
- Piano di lavoro in acciaio inox finitura scotch brite con angoli saldati;
- Alzatina standard completamente saldata;
- Ripiano intermedio in acciaio inox finitura scotch brite con omega di rinforzo;
- Bordo piano mm. 40;
- Guide per cassetto standard: Per elementi con alzatina posteriore, le gambe sono rientranti di mm 50.
- I modelli da 220mm in poi hanno 6 gambe

SPECIFICHE TECNICHE

TAVOLO DA LAVORO

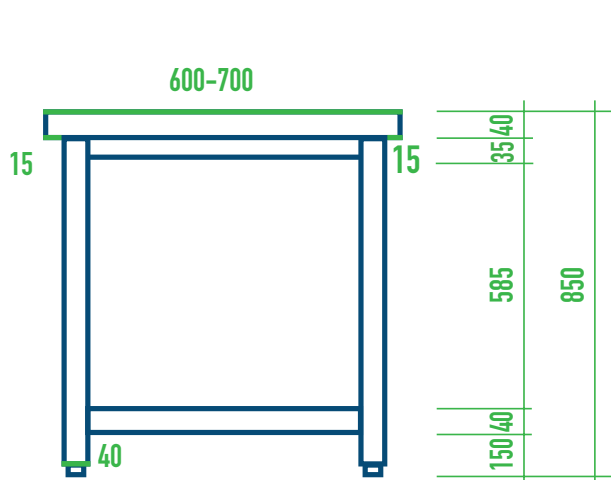

TAVOLO DA LAVORO CON SOTTOPIANO E ALZATINA

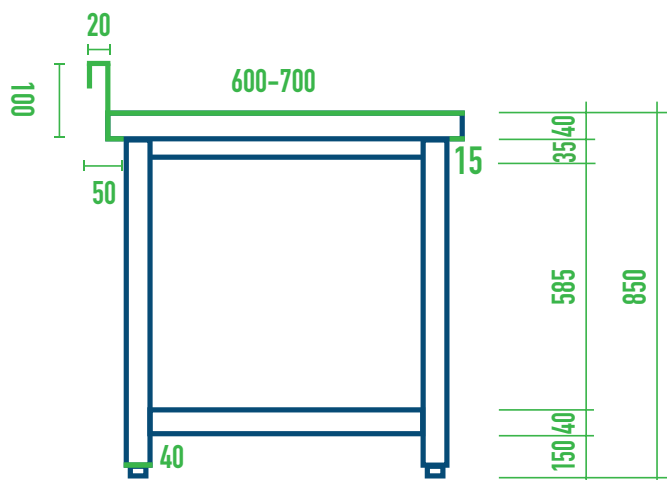

60

Tavolo su telaio

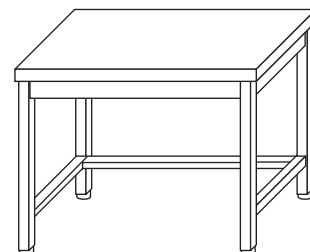

CODICE	DIMENSIONI cm	
TTG6 07	70x60x85	
TTG6 08	80x60x85	
TTG6 09	90x60x85	
TTG6 10	100x60x85	
TTG6 11	110x60x85	
TTG6 12	120x60x85	
TTG6 13	130x60x85	
TTG6 14	140x60x85	
TTG6 15	150x60x85	
TTG6 16	160x60x85	
TTG6 17	170x60x85	
TTG6 18	180x60x85	
TTG6 19	190x60x85	
TTG6 20	200x60x85	
TTG6 21	210x60x85	
TTG6 22	220x60x85	
TTG6 23	230x60x85	
TTG6 24	240x60x85	
TTG6 25	250x60x85	
TTG6 26	260x60x85	
TTG6 27	270x60x85	
TTG6 28	280x60x85	
TTG6 29	290x60x85	
TTG6 30	300x60x85	

70

Tavolo su telaio

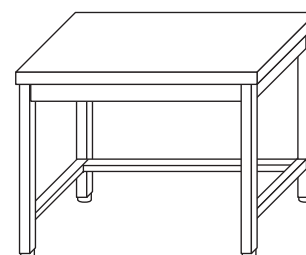

CODICE	DIMENSIONI cm	
TTG7 07	70x70x85	
TTG7 08	80x70x85	
TTG7 09	90x70x85	
TTG7 10	100x70x85	
TTG7 11	110x70x85	
TTG7 12	120x70x85	
TTG7 13	130x70x85	
TTG7 14	140x70x85	
TTG7 15	150x70x85	
TTG7 16	160x70x85	
TTG7 17	170x70x85	
TTG7 18	180x70x85	
TTG7 19	190x70x85	
TTG7 20	200x70x85	
TTG7 21	210x70x85	
TTG7 22	220x70x85	
TTG7 23	230x70x85	
TTG7 24	240x70x85	
TTG7 25	250x70x85	
TTG7 26	260x70x85	
TTG7 27	270x70x85	
TTG7 28	280x70x85	
TTG7 29	290x70x85	
TTG7 30	300x70x85	

60

Tavolo su telaio con alzatina

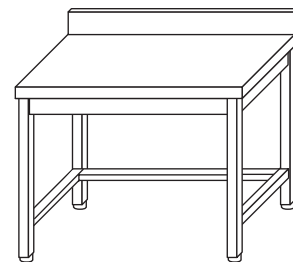

CODICE	DIMENSIONI cm
TTA6 07	70x60x85
TTA6 08	80x60x85
TTA6 09	90x60x85
TTA6 10	100x60x85
TTA6 11	110x60x85
TTA6 12	120x60x85
TTA6 13	130x60x85
TTA6 14	140x60x85
TTA6 15	150x60x85
TTA6 16	160x60x85
TTA6 17	170x60x85
TTA6 18	180x60x85
TTA6 19	190x60x85
TTA6 20	200x60x85
TTA6 21	210x60x85
TTA6 22	220x60x85
TTA6 23	230x60x85
TTA6 24	240x60x85
TTA6 25	250x60x85
TTA6 26	260x60x85
TTA6 27	270x60x85
TTA6 28	280x60x85
TTA6 29	290x60x85
TTA6 30	300x60x85

70

Tavolo su telaio con alzatina

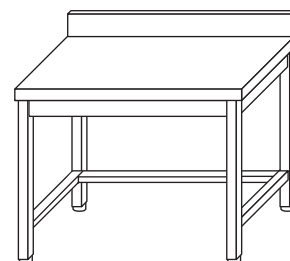

CODICE	DIMENSIONI cm
TTA7 07	70x70x85
TTA7 08	80x70x85
TTA7 09	90x70x85
TTA7 10	100x70x85
TTA7 11	110x70x85
TTA7 12	120x70x85
TTA7 13	130x70x85
TTA7 14	140x70x85
TTA7 15	150x70x85
TTA7 16	160x70x85
TTA7 17	170x70x85
TTA7 18	180x70x85
TTA7 19	190x70x85
TTA7 20	200x70x85
TTA7 21	210x70x85
TTA7 22	220x70x85
TTA7 23	230x70x85
TTA7 24	240x70x85
TTA7 25	250x70x85
TTA7 26	260x70x85
TTA7 27	270x70x85
TTA7 28	280x70x85
TTA7 29	290x70x85
TTA7 30	300x70x85

60

Tavolo con ripiano inferiore

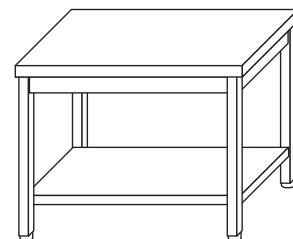

CODICE	DIMENSIONI cm	
TTS6 07	70x60x85	
TTS6 08	80x60x85	
TTS6 09	90x60x85	
TTS6 10	100x60x85	
TTS6 11	110x60x85	
TTS6 12	120x60x85	
TTS6 13	130x60x85	
TTS6 14	140x60x85	
TTS6 15	150x60x85	
TTS6 16	160x60x85	
TTS6 17	170x60x85	
TTS6 18	180x60x85	
TTS6 19	190x60x85	
TTS6 20	200x60x85	
TTS6 21	210x60x85	
TTS6 22	220x60x85	
TTS6 23	230x60x85	
TTS6 24	240x60x85	
TTS6 25	250x60x85	
TTS6 26	260x60x85	
TTS6 27	270x60x85	
TTS6 28	280x60x85	
TTS6 29	290x60x85	
TTS6 30	300x60x85	

70

Tavolo con ripiano inferiore

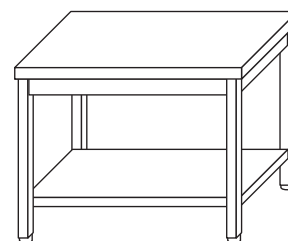

CODICE	DIMENSIONI cm	
TTS7 07	70x70x85	
TTS7 08	80x70x85	
TTS7 09	90x70x85	
TTS7 10	100x70x85	
TTS7 11	110x70x85	
TTS7 12	120x70x85	
TTS7 13	130x70x85	
TTS7 14	140x70x85	
TTS7 15	150x70x85	
TTS7 16	160x70x85	
TTS7 17	170x70x85	
TTS7 18	180x70x85	
TTS7 19	190x70x85	
TTS7 20	200x70x85	
TTS7 21	210x70x85	
TTS7 22	220x70x85	
TTS7 23	230x70x85	
TTS7 24	240x70x85	
TTS7 25	250x70x85	
TTS7 26	260x70x85	
TTS7 27	270x70x85	
TTS7 28	280x70x85	
TTS7 29	290x70x85	
TTS7 30	300x70x85	

60

Tavolo con ripiano inferiore e alzatina

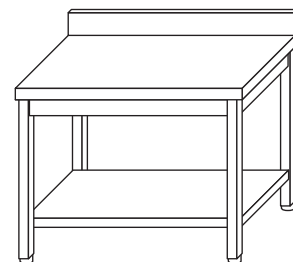

CODICE	DIMENSIONI cm	
TSA6 07	70x60x85	
TSA6 08	80x60x85	
TSA6 09	90x60x85	
TSA6 10	100x60x85	
TSA6 11	110x60x85	
TSA6 12	120x60x85	
TSA6 13	130x60x85	
TSA6 14	140x60x85	
TSA6 15	150x60x85	
TSA6 16	160x60x85	
TSA6 17	170x60x85	
TSA6 18	180x60x85	
TSA6 19	190x60x85	
TSA6 20	200x60x85	
TSA6 21	210x60x85	
TSA6 22	220x60x85	
TSA6 23	230x60x85	
TSA6 24	240x60x85	
TSA6 25	250x60x85	
TSA6 26	260x60x85	
TSA6 27	270x60x85	
TSA6 28	280x60x85	
TSA6 29	290x60x85	
TSA6 30	300x60x85	

70

Tavolo con ripiano inferiore e alzatina

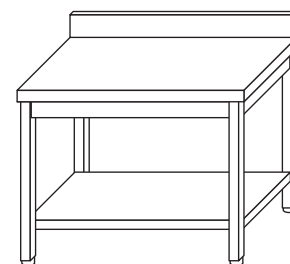

CODICE	DIMENSIONI cm	
TSA7 07	70x70x85	
TSA7 08	80x70x85	
TSA7 09	90x70x85	
TSA7 10	100x70x85	
TSA7 11	110x70x85	
TSA7 12	120x70x85	
TSA7 13	130x70x85	
TSA7 14	140x70x85	
TSA7 15	150x70x85	
TSA7 16	160x70x85	
TSA7 17	170x70x85	
TSA7 18	180x70x85	
TSA7 19	190x70x85	
TSA7 20	200x70x85	
TSA7 21	210x70x85	
TSA7 22	220x70x85	
TSA7 23	230x70x85	
TSA7 24	240x70x85	
TSA7 25	250x70x85	
TSA7 26	260x70x85	
TSA7 27	270x70x85	
TSA7 28	280x70x85	
TSA7 29	290x70x85	
TSA7 30	300x70x85	

60

Tavolo con 2 ripiani

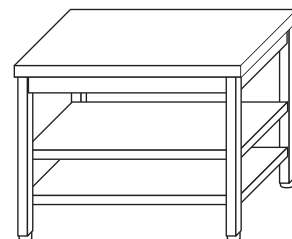

CODICE	DIMENSIONI cm	
TTR6 07	70x60x85	
TTR6 08	80x60x85	
TTR6 09	90x60x85	
TTR6 10	100x60x85	
TTR6 11	110x60x85	
TTR6 12	120x60x85	
TTR6 13	130x60x85	
TTR6 14	140x60x85	
TTR6 15	150x60x85	
TTR6 16	160x60x85	
TTR6 17	170x60x85	
TTR6 18	180x60x85	
TTR6 19	190x60x85	
TTR6 20	200x60x85	
TTR6 21	210x60x85	
TTR6 22	220x60x85	
TTR6 23	230x60x85	
TTR6 24	240x60x85	
TTR6 25	250x60x85	
TTR6 26	260x60x85	
TTR6 27	270x60x85	
TTR6 28	280x60x85	
TTR6 29	290x60x85	
TTR6 30	300x60x85	

70

Tavolo con 2 ripiani

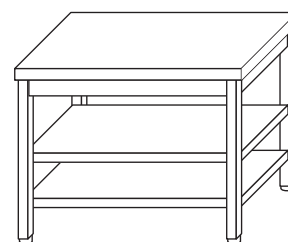

CODICE	DIMENSIONI cm	
TTR7 07	70x70x85	
TTR7 08	80x70x85	
TTR7 09	90x70x85	
TTR7 10	100x70x85	
TTR7 11	110x70x85	
TTR7 12	120x70x85	
TTR7 13	130x70x85	
TTR7 14	140x70x85	
TTR7 15	150x70x85	
TTR7 16	160x70x85	
TTR7 17	170x70x85	
TTR7 18	180x70x85	
TTR7 19	190x70x85	
TTR7 20	200x70x85	
TTR7 21	210x70x85	
TTR7 22	220x70x85	
TTR7 23	230x70x85	
TTR7 24	240x70x85	
TTR7 25	250x70x85	
TTR7 26	260x70x85	
TTR7 27	270x70x85	
TTR7 28	280x70x85	
TTR7 29	290x70x85	
TTR7 30	300x70x85	

60

Tavolo con 2 ripiani e alzatina

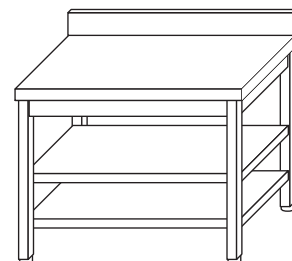

CODICE	DIMENSIONI cm	
TRA6 07	70x60x85	
TRA6 08	80x60x85	
TRA6 09	90x60x85	
TRA6 10	100x60x85	
TRA6 11	110x60x85	
TRA6 12	120x60x85	
TRA6 13	130x60x85	
TRA6 14	140x60x85	
TRA6 15	150x60x85	
TRA6 16	160x60x85	
TRA6 17	170x60x85	
TRA6 18	180x60x85	
TRA6 19	190x60x85	
TRA6 20	200x60x85	
TRA6 21	210x60x85	
TRA6 22	220x60x85	
TRA6 23	230x60x85	
TRA6 24	240x60x85	
TRA6 25	250x60x85	
TRA6 26	260x60x85	
TRA6 27	270x60x85	
TRA6 28	280x60x85	
TRA6 29	290x60x85	
TRA6 30	300x60x85	

70

Tavolo con 2 ripiani e alzatina

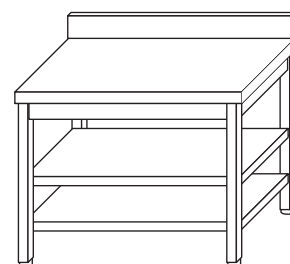

CODICE	DIMENSIONI cm	
TRA7 07	70x70x85	
TRA7 08	80x70x85	
TRA7 09	90x70x85	
TRA7 10	100x70x85	
TRA7 11	110x70x85	
TRA7 12	120x70x85	
TRA7 13	130x70x85	
TRA7 14	140x70x85	
TRA7 15	150x70x85	
TRA7 16	160x70x85	
TRA7 17	170x70x85	
TRA7 18	180x70x85	
TRA7 19	190x70x85	
TRA7 20	200x70x85	
TRA7 21	210x70x85	
TRA7 22	220x70x85	
TRA7 23	230x70x85	
TRA7 24	240x70x85	
TRA7 25	250x70x85	
TRA7 26	260x70x85	
TRA7 27	270x70x85	
TRA7 28	280x70x85	
TRA7 29	290x70x85	
TRA7 30	300x70x85	

60

Tavolo armadiato a giorno con ripiano intermedio

regolabile in 3 posizioni

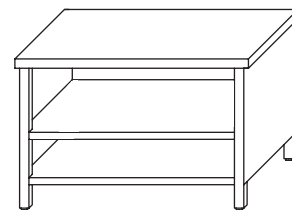

CODICE	DIMENSIONI cm	
TMR6 07	70x60x85	
TMR6 08	80x60x85	
TMR6 09	90x60x85	
TMR6 10	100x60x85	
TMR6 11	110x60x85	
TMR6 12	120x60x85	
TMR6 13	130x60x85	
TMR6 14	140x60x85	
TMR6 15	150x60x85	
TMR6 16	160x60x85	
TMR6 17	170x60x85	
TMR6 18	180x60x85	
TMR6 19	190x60x85	
TMR6 20	200x60x85	
TMR6 21	210x60x85	
TMR6 22	220x60x85	
TMR6 23	230x60x85	
TMR6 24	240x60x85	
TMR6 25	250x60x85	
TMR6 26	260x60x85	
TMR6 27	270x60x85	
TMR6 28	280x60x85	
TMR6 29	290x60x85	
TMR6 30	300x60x85	

70

Tavolo armadiato a giorno con ripiano intermedio regolabile in 3 posizioni

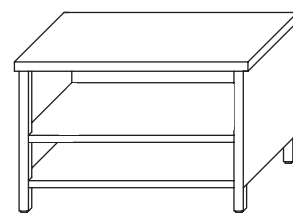

CODICE	DIMENSIONI cm	
TMR7 07	70x70x85	
TMR7 08	80x70x85	
TMR7 09	90x70x85	
TMR7 10	100x70x85	
TMR7 11	110x70x85	
TMR7 12	120x70x85	
TMR7 13	130x70x85	
TMR7 14	140x70x85	
TMR7 15	150x70x85	
TMR7 16	160x70x85	
TMR7 17	170x70x85	
TMR7 18	180x70x85	
TMR7 19	190x70x85	
TMR7 20	200x70x85	
TMR7 21	210x70x85	
TMR7 22	220x70x85	
TMR7 23	230x70x85	
TMR7 24	240x70x85	
TMR7 25	250x70x85	
TMR7 26	260x70x85	
TMR7 27	270x70x85	
TMR7 28	280x70x85	
TMR7 29	290x70x85	
TMR7 30	300x70x85	

60

Tavolo armadiato a giorno con alzatina e ripiano intermedio regolabile in 3 posizioni

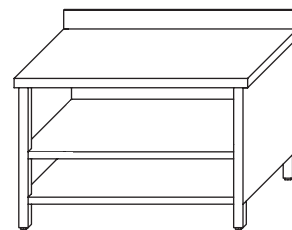

CODICE	DIMENSIONI cm	
TMRA6 07	70x60x85	
TMRA6 08	80x60x85	
TMRA6 09	90x60x85	
TMRA6 10	100x60x85	
TMRA6 11	110x60x85	
TMRA6 12	120x60x85	
TMRA6 13	130x60x85	
TMRA6 14	140x60x85	
TMRA6 15	150x60x85	
TMRA6 16	160x60x85	
TMRA6 17	170x60x85	
TMRA6 18	180x60x85	
TMRA6 19	190x60x85	
TMRA6 20	200x60x85	
TMRA6 21	210x60x85	
TMRA6 22	220x60x85	
TMRA6 23	230x60x85	
TMRA6 24	240x60x85	
TMRA6 25	250x60x85	
TMRA6 26	260x60x85	
TMRA6 27	270x60x85	
TMRA6 28	280x60x85	
TMRA6 29	290x60x85	
TMRA6 30	300x60x85	

70

Tavolo armadiato a giorno con alzatina e ripiano intermedio regolabile in 3 posizioni

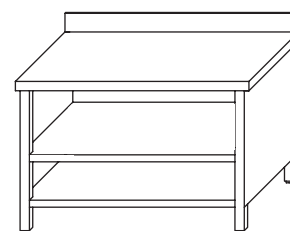

CODICE	DIMENSIONI cm
TMRA7 07	70x70x85
TMRA7 08	80x70x85
TMRA7 09	90x70x85
TMRA7 10	100x70x85
TMRA7 11	110x70x85
TMRA7 12	120x70x85
TMRA7 13	130x70x85
TMRA7 14	140x70x85
TMRA7 15	150x70x85
TMRA7 16	160x70x85
TMRA7 17	170x70x85
TMRA7 18	180x70x85
TMRA7 19	190x70x85
TMRA7 20	200x70x85
TMRA7 21	210x70x85
TMRA7 22	220x70x85
TMRA7 23	230x70x85
TMRA7 24	240x70x85
TMRA7 25	250x70x85
TMRA7 26	260x70x85
TMRA7 27	270x70x85
TMRA7 28	280x70x85
TMRA7 29	290x70x85
TMRA7 30	300x70x85

60

Tavolo armadiato con ante scorrevoli e ripiano intermedio

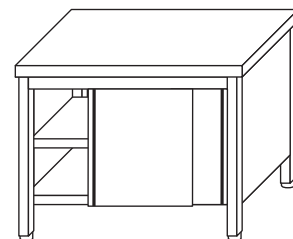

CODICE	DIMENSIONI cm	
TSR6 10	100x60x85	
TSR6 11	110x60x85	
TSR6 12	120x60x85	
TSR6 13	130x60x85	
TSR6 14	140x60x85	
TSR6 15	150x60x85	
TSR6 16	160x60x85	
TSR6 17	170x60x85	
TSR6 18	180x60x85	
TSR6 19	190x60x85	
TSR6 20	200x60x85	
TSR6 21	210x60x85	
TSR6 22	220x60x85	
TSR6 23	230x60x85	
TSR6 24	240x60x85	
TSR6 25	250x60x85	
TSR6 26	260x60x85	
TSR6 27	270x60x85	
TSR6 28	280x60x85	
TSR6 29	290x60x85	
TSR6 30	300x60x85	

70

Tavolo armadiato con ante scorrevoli e ripiano intermedio

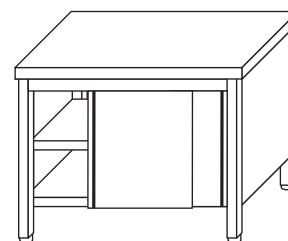

CODICE	DIMENSIONI cm
TSR7 10	100x70x85
TSR7 11	110x70x85
TSR7 12	120x70x85
TSR7 13	130x70x85
TSR7 14	140x70x85
TSR7 15	150x70x85
TSR7 16	160x70x85
TSR7 17	170x70x85
TSR7 18	180x70x85
TSR7 19	190x70x85
TSR7 20	200x70x85
TSR7 21	210x70x85
TSR7 22	220x70x85
TSR7 23	230x70x85
TSR7 24	240x70x85
TSR7 25	250x70x85
TSR7 26	260x70x85
TSR7 27	270x70x85
TSR7 28	280x70x85
TSR7 29	290x70x85
TSR7 30	300x70x85

60

Tavolo armadiato con ante scorrevoli, ripiano intermedio e alzatina

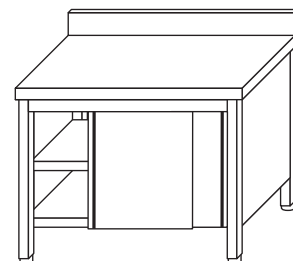

CODICE	DIMENSIONI cm	
TSRA6 10	100x60x85	
TSRA6 11	110x60x85	
TSRA6 12	120x60x85	
TSRA6 13	130x60x85	
TSRA6 14	140x60x85	
TSRA6 15	150x60x85	
TSRA6 16	160x60x85	
TSRA6 17	170x60x85	
TSRA6 18	180x60x85	
TSRA6 19	190x60x85	
TSRA6 20	200x60x85	
TSRA6 21	210x60x85	
TSRA6 22	220x60x85	
TSRA6 23	230x60x85	
TSRA6 24	240x60x85	
TSRA6 25	250x60x85	
TSRA6 26	260x60x85	
TSRA6 27	270x60x85	
TSRA6 28	280x60x85	
TSRA6 29	290x60x85	
TSRA6 30	300x60x85	

70

Tavolo armadiato con ante scorrevoli, ripiano intermedio e alzatina

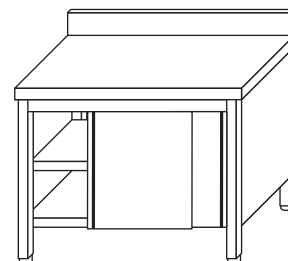

CODICE	DIMENSIONI cm	
TSRA7 10	100x70x85	
TSRA7 11	110x70x85	
TSRA7 12	120x70x85	
TSRA7 13	130x70x85	
TSRA7 14	140x70x85	
TSRA7 15	150x70x85	
TSRA7 16	160x70x85	
TSRA7 17	170x70x85	
TSRA7 18	180x70x85	
TSRA7 19	190x70x85	
TSRA7 20	200x70x85	
TSRA7 21	210x70x85	
TSRA7 22	220x70x85	
TSRA7 23	230x70x85	
TSRA7 24	240x70x85	
TSRA7 25	250x70x85	
TSRA7 26	260x70x85	
TSRA7 27	270x70x85	
TSRA7 28	280x70x85	
TSRA7 29	290x70x85	
TSRA7 30	300x70x85	

60

Tavolo armadiato con ante scorrevoli su 2 lati

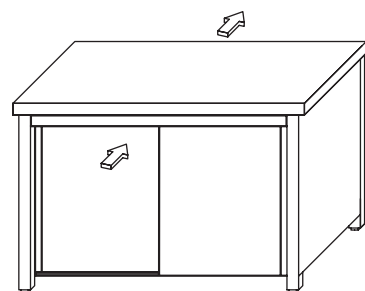

CODICE	DIMENSIONI cm	
TSS6 12	120x60x85	
TSS6 13	130x60x85	
TSS6 14	140x60x85	
TSS6 15	150x60x85	
TSS6 16	160x60x85	
TSS6 17	170x60x85	
TSS6 18	180x60x85	
TSS6 19	190x60x85	
TSS6 20	200x60x85	
TSS6 21	210x60x85	
TSS6 22	220x60x85	
TSS6 23	230x60x85	
TSS6 24	240x60x85	
TSS6 25	250x60x85	
TSS6 26	260x60x85	
TSS6 27	270x60x85	
TSS6 28	280x60x85	
TSS6 29	290x60x85	
TSS6 30	300x60x85	

70

Tavolo armadiato con ante scorrevoli su 2 lati

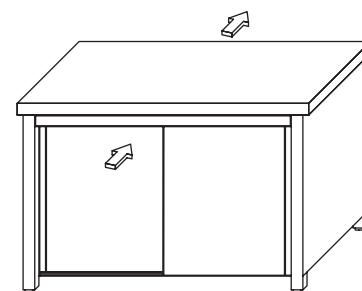

CODICE	DIMENSIONI cm	
TSS7 12	120x70x85	
TSS7 13	130x70x85	
TSS7 14	140x70x85	
TSS7 15	150x70x85	
TSS7 16	160x70x85	
TSS7 17	170x70x85	
TSS7 18	180x70x85	
TSS7 19	190x70x85	
TSS7 20	200x70x85	
TSS7 21	210x70x85	
TSS7 22	220x70x85	
TSS7 23	230x70x85	
TSS7 24	240x70x85	
TSS7 25	250x70x85	
TSS7 26	260x70x85	
TSS7 27	270x70x85	
TSS7 28	280x70x85	
TSS7 29	290x70x85	
TSS7 30	300x70x85	

80

Tavolo armadiato con ante scorrevoli su 2 lati

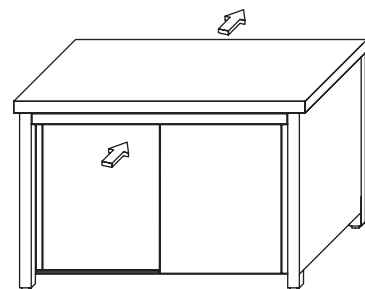

CODICE	DIMENSIONI cm	
TSS8 12	120x80x85	
TSS8 13	130x80x85	
TSS8 14	140x80x85	
TSS8 15	150x80x85	
TSS8 16	160x80x85	
TSS8 17	170x80x85	
TSS8 18	180x80x85	
TSS8 19	190x80x85	
TSS8 20	200x80x85	
TSS8 21	210x80x85	
TSS8 22	220x80x85	
TSS8 23	230x80x85	
TSS8 24	240x80x85	
TSS8 25	250x80x85	
TSS8 26	260x80x85	
TSS8 27	270x80x85	
TSS8 28	280x80x85	
TSS8 29	290x80x85	
TSS8 30	300x80x85	

60

Tavolo armadiato con ante a battente e ripiano intermedio

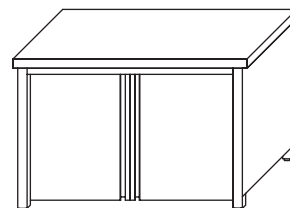

CODICE	DIMENSIONI cm	
TBR6 07	70x60x85	
TBR6 08	80x60x85	
TBR6 09	90x60x85	
TBR6 10	100x60x85	
TBR6 11	110x60x85	
TBR6 12	120x60x85	

Tavolo armadiato con ante a battente, ripiano intermedio e alzatina

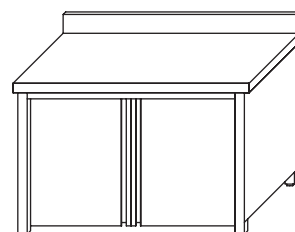

CODICE	DIMENSIONI cm	
TBRA6 07	70x60x85	
TBRA6 08	80x60x85	
TBRA6 09	90x60x85	
TBRA6 10	100x60x85	
TBRA6 11	110x60x85	
TBRA6 12	120x60x85	

70

Tavolo armadiato con ante a battente e ripiano intermedio

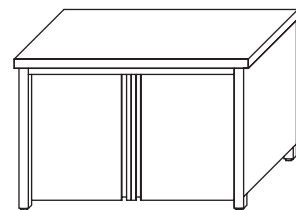

CODICE	DIMENSIONI cm	
TBR7 07	70x70x85	
TBR7 08	80x70x85	
TBR7 09	90x70x85	
TBR7 10	100x70x85	
TBR7 11	110x70x85	
TBR7 12	120x70x85	

Tavolo armadiato con ante a battente, ripiano intermedio e alzatina

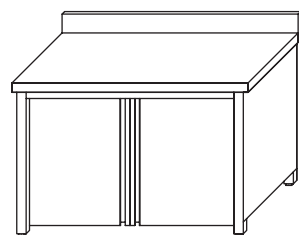

CODICE	DIMENSIONI cm	
TBRA7 07	70x70x85	
TBRA7 08	80x70x85	
TBRA7 09	90x70x85	
TBRA7 10	100x70x85	
TBRA7 11	110x70x85	
TBRA7 12	120x70x85	

60

Tavolo armadiato con ante scorrevoli e cassettera

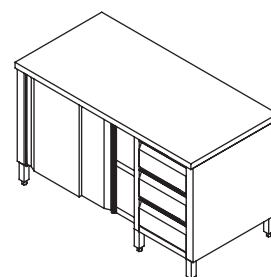

CODICE	DIMENSIONI cm	
TSC6 14	140x60x85	
TSC6 15	150x60x85	
TSC6 16	160x60x85	
TSC6 17	170x60x85	
TSC6 18	180x60x85	
TSC6 19	190x60x85	
TSC6 20	200x60x85	
TSC6 21	210x60x85	
TSC6 22	220x60x85	
TSC6 23	230x60x85	
TSC6 24	240x60x85	

Tavolo armadiato con ante a battente e cassettera

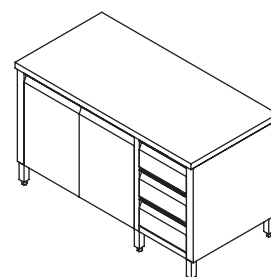

CODICE	DIMENSIONI cm	
TBC6 10	100x60x85	
TBC6 11	110x60x85	
TBC6 12	120x60x85	
TBC6 13	130x60x85	
TBC6 14	140x60x85	

70

Tavolo armadiato con ante scorrevoli e cassettera

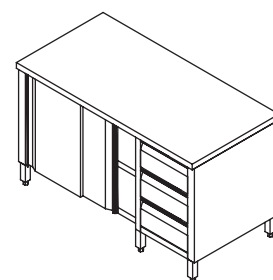

CODICE	DIMENSIONI cm	
TSC7 14	140x70x85	
TSC7 15	150x70x85	
TSC7 16	160x70x85	
TSC7 17	170x70x85	
TSC7 18	180x70x85	
TSC7 19	190x70x85	
TSC7 20	200x70x85	
TSC7 21	210x70x85	
TSC7 22	220x70x85	
TSC7 23	230x70x85	
TSC7 24	240x70x85	

Tavolo armadiato con ante a battente e cassettera

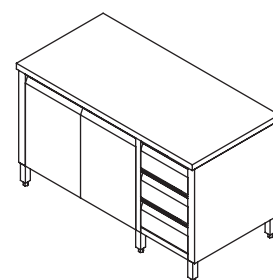

CODICE	DIMENSIONI cm	
TBC7 10	100x70x85	
TBC7 11	110x70x85	
TBC7 12	120x70x85	
TBC7 13	130x70x85	
TBC7 14	140x70x85	

60

Tavolo armadiato con ante scorrevoli, cassettera e alzatina

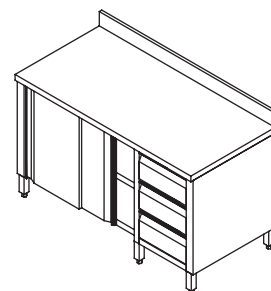

CODICE	DIMENSIONI cm	
TSCA6 14	140x60x85	
TSCA6 15	150x60x85	
TSCA6 16	160x60x85	
TSCA6 17	170x60x85	
TSCA6 18	180x60x85	
TSCA6 19	190x60x85	
TSCA6 20	200x60x85	
TSCA6 21	210x60x85	
TSCA6 22	220x60x85	
TSCA6 23	230x60x85	
TSCA6 24	240x60x85	

Tavolo armadiato con ante a battente, cassettera e alzatina

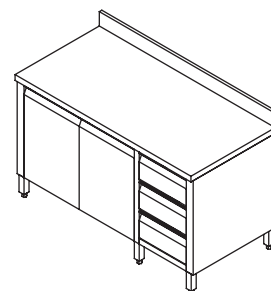

CODICE	DIMENSIONI cm	
TBCA6 10	100x60x85	
TBCA6 11	110x60x85	
TBCA6 12	120x60x85	
TBCA6 13	130x60x85	
TBCA6 14	140x60x85	

70

Tavolo armadiato con ante scorrevoli, cassettera e alzatina

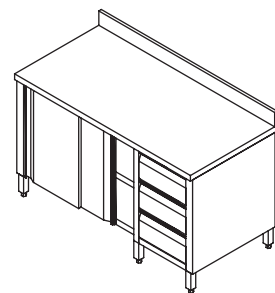

CODICE	DIMENSIONI cm	
TSCA7 14	140x70x85	
TSCA7 15	150x70x85	
TSCA7 16	160x70x85	
TSCA7 17	170x70x85	
TSCA7 18	180x70x85	
TSCA7 19	190x70x85	
TSCA7 20	200x70x85	
TSCA7 21	210x70x85	
TSCA7 22	220x70x85	
TSCA7 23	230x70x85	
TSCA7 24	240x70x85	

Tavolo armadiato con ante a battente, cassettera e alzatina

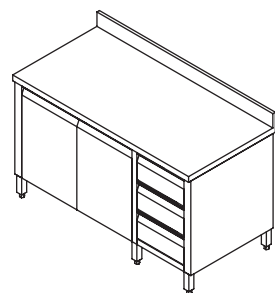

CODICE	DIMENSIONI cm	
TBCA7 10	100x70x85	
TBCA7 11	110x70x85	
TBCA7 12	120x70x85	
TBCA7 13	130x70x85	
TBCA7 14	140x70x85	

60

Tavolo armadiato con ante scorrevoli e cassetti superiori

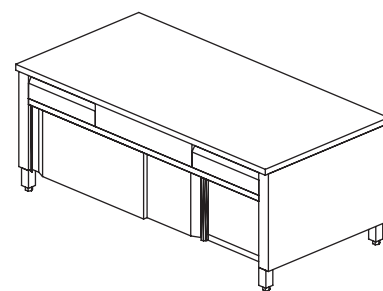

CODICE	DIMENSIONI cm
TSCO6 10	100x60x85
TSCO6 11	110x60x85
TSCO6 12	120x60x85
TSCO6 13	130x60x85
TSCO6 14	140x60x85
TSCO6 15	150x60x85
TSCO6 16	160x60x85
TSCO6 17	170x60x85
TSCO6 18	180x60x85
TSCO6 19	190x60x85
TSCO6 20	200x60x85
TSCO6 21	210x60x85
TSCO6 22	220x60x85
TSCO6 23	230x60x85
TSCO6 24	240x60x85

70

Tavolo armadiato con ante scorrevoli e cassetti superiori

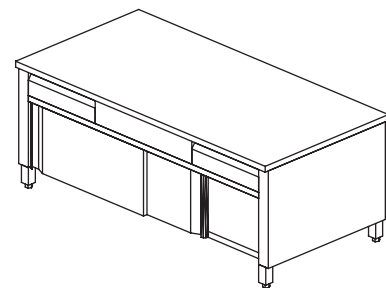

CODICE	DIMENSIONI cm	
TSCO7 10	100x70x85	
TSCO7 11	110x70x85	
TSCO7 12	120x70x85	
TSCO7 13	130x70x85	
TSCO7 14	140x70x85	
TSCO7 15	150x70x85	
TSCO7 16	160x70x85	
TSCO7 17	170x70x85	
TSCO7 18	180x70x85	
TSCO7 19	190x70x85	
TSCO7 20	200x70x85	
TSCO7 21	210x70x85	
TSCO7 22	220x70x85	
TSCO7 23	230x70x85	
TSCO7 24	240x70x85	

60

Tavolo armadiato con ante scorrevoli, cassetti superiori e alzatina

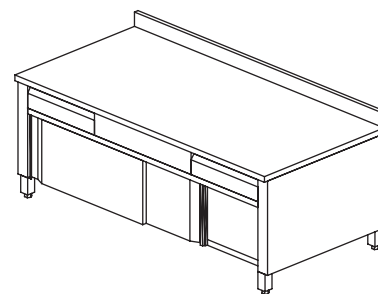

CODICE	DIMENSIONI cm	
TSCOA6 10	100x60x85	
TSCOA6 11	110x60x85	
TSCOA6 12	120x60x85	
TSCOA6 13	130x60x85	
TSCOA6 14	140x60x85	
TSCOA6 15	150x60x85	
TSCOA6 16	160x60x85	
TSCOA6 17	170x60x85	
TSCOA6 18	180x60x85	
TSCOA6 19	190x60x85	
TSCOA6 20	200x60x85	
TSCOA6 21	210x60x85	
TSCOA6 22	220x60x85	
TSCOA6 23	230x60x85	
TSCOA6 24	240x60x85	

70

Tavolo armadiato con ante scorrevoli, cassetti superiori e alzatina

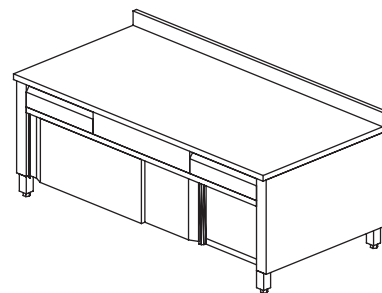

CODICE	DIMENSIONI cm	
TSCOA7 10	100x70x85	
TSCOA7 11	110x70x85	
TSCOA7 12	120x70x85	
TSCOA7 13	130x70x85	
TSCOA7 14	140x70x85	
TSCOA7 15	150x70x85	
TSCOA7 16	160x70x85	
TSCOA7 17	170x70x85	
TSCOA7 18	180x70x85	
TSCOA7 19	190x70x85	
TSCOA7 20	200x70x85	
TSCOA7 21	210x70x85	
TSCOA7 22	220x70x85	
TSCOA7 23	230x70x85	
TSCOA7 24	240x70x85	

60

Tavolo armadiato con ante a battente e cassetti superiori

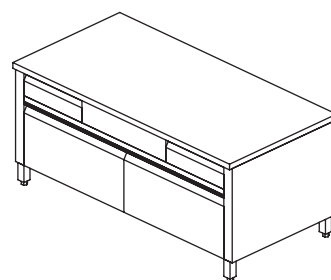

CODICE	DIMENSIONI cm	
TBCO6 06	60x60x85	
TBCO6 07	70x60x85	
TBCO6 08	80x60x85	
TBCO6 09	90x60x85	
TBCO6 10	100x60x85	
TBCO6 11	110x60x85	
TBCO6 12	120x60x85	
TBCO6 13	130x60x85	
TBCO6 14	140x60x85	

Tavolo armadiato con ante a battente, cassetti superiori e alzatina

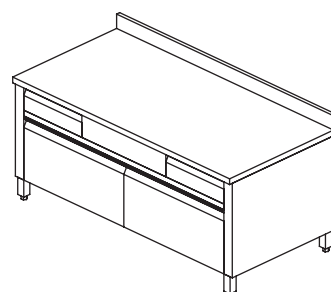

CODICE	DIMENSIONI cm	
TBCOA6 06	60x60x85	
TBCOA6 07	70x60x85	
TBCOA6 08	80x60x85	
TBCOA6 09	90x60x85	
TBCOA6 10	100x60x85	
TBCOA6 11	110x60x85	
TBCOA6 12	120x60x85	
TBCOA6 13	130x60x85	
TBCOA6 14	140x60x85	

70

Tavolo armadiato con ante a battente e cassetti superiori

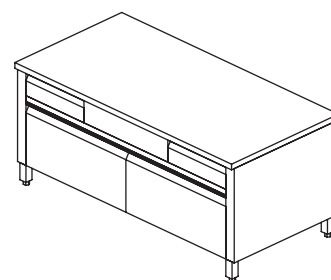

CODICE	DIMENSIONI cm	
TBCO7 06	60x70x85	
TBCO7 07	70x70x85	
TBCO7 08	80x70x85	
TBCO7 09	90x70x85	
TBCO7 10	100x70x85	
TBCO7 11	110x70x85	
TBCO7 12	120x70x85	
TBCO7 13	130x70x85	
TBCO7 14	140x70x85	

Tavolo armadiato con ante a battente, cassetti superiori e alzatina

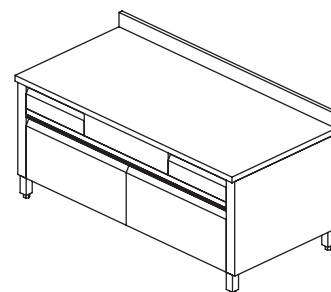

CODICE	DIMENSIONI cm	
TBCOA7 06	60x60x85	
TBCOA7 07	70x60x85	
TBCOA7 08	80x60x85	
TBCOA7 09	90x60x85	
TBCOA7 10	100x60x85	
TBCOA7 11	110x60x85	
TBCOA7 12	120x60x85	
TBCOA7 13	130x60x85	
TBCOA7 14	140x60x85	

30

Ripiano d'appoggio da banco

2 ripiani

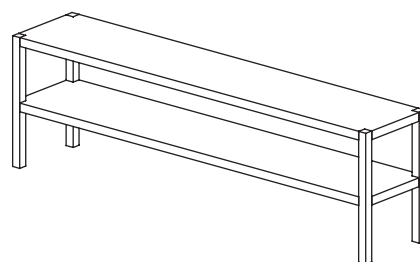

CODICE	DIMENSIONI cm
RIP 10	100x30x60
RIP 12	120x30x60
RIP 14	140x30x60
RIP 16	160x30x60
RIP 18	180x30x60
RIP 20	200x30x60

Cassettiera 3 cassetti

Con guide

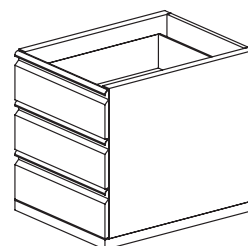

CODICE	DIMENSIONI cm
CAS3 60	37x60x56
CAS3 70	37x70x56

Cassettiera 4 cassetti

Con guide

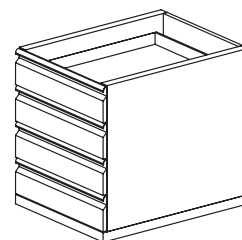

CODICE	DIMENSIONI cm
CAS4 60	37x60x56
CAS4 70	37x70x56

Cassettone

Con guide

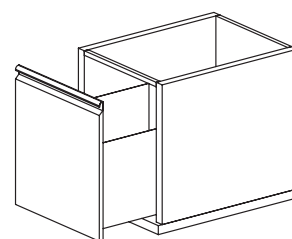

CODICE	DIMENSIONI cm	
CAS1 60	37x60x56	
CAS1 70	37x70x56	

Cassettiera 2 cassetti

Con guide

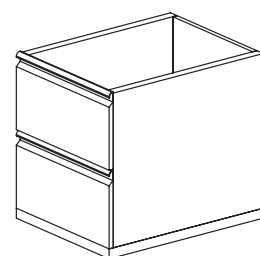

CODICE	DIMENSIONI cm	
CAS2 60	37x60x56	
CAS2 70	37x70x56	

Cassetto singolo

Con guide

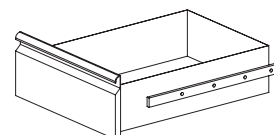

CODICE	DIMENSIONI cm	
CSS 1	37x55x15	
CSS 2	37x55x20	
CSS 3	41x61x15	
CSS 5	60x61x15	
CSS 6	71x65x15	

Cassettiera con top

3 Cassetti

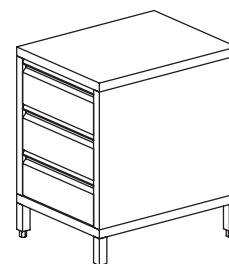

CODICE	DIMENSIONI cm	
CAT 60	50x60x85	
CAT 70	50x70x85	

Tramoggia con top

Basculante

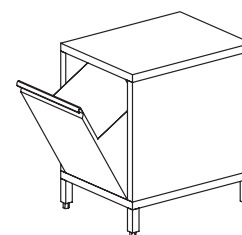

CODICE	DIMENSIONI cm	
TRA 60	50x60x85	
TRA 70	50x70x85	

60

Top Tamburrato

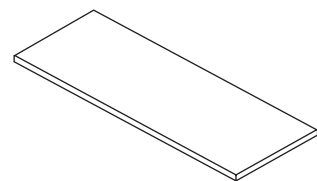

CODICE	DIMENSIONI cm	
TOP6 07	70x60x4	
TOP6 08	80x60x4	
TOP6 09	90x60x4	
TOP6 10	100x60x4	
TOP6 11	110x60x4	
TOP6 12	120x60x4	
TOP6 13	130x60x4	
TOP6 14	140x60x4	
TOP6 15	150x60x4	
TOP6 16	160x60x4	
TOP6 17	170x60x4	
TOP6 18	180x60x4	
TOP6 19	190x60x4	
TOP6 20	200x60x4	
TOP6 21	210x60x4	
TOP6 22	220x60x4	
TOP6 23	230x60x4	
TOP6 24	240x60x4	
TOP6 25	250x60x4	
TOP6 26	260x60x4	
TOP6 27	270x60x4	
TOP6 28	280x60x4	
TOP6 29	290x60x4	
TOP6 30	300x60x4	

70

Top Tamburrato

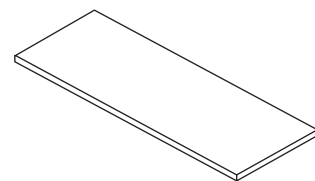

CODICE	DIMENSIONI cm	
TOP7 07	70x70x4	
TOP7 08	80x70x4	
TOP7 09	90x70x4	
TOP7 10	100x70x4	
TOP7 11	110x70x4	
TOP7 12	120x70x4	
TOP7 13	130x70x4	
TOP7 14	140x70x4	
TOP7 15	150x70x4	
TOP7 16	160x70x4	
TOP7 17	170x70x4	
TOP7 18	180x70x4	
TOP7 19	190x70x4	
TOP7 20	200x70x4	
TOP7 21	210x70x4	
TOP7 22	220x70x4	
TOP7 23	230x70x4	
TOP7 24	240x70x4	
TOP7 25	250x70x4	
TOP7 26	260x70x4	
TOP7 27	270x70x4	
TOP7 28	280x70x4	
TOP7 29	290x70x4	
TOP7 30	300x70x4	

60

Top con alzataina Tamburrato

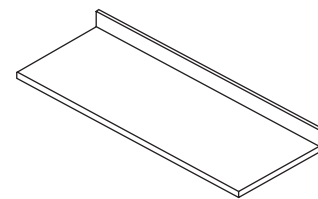

CODICE	DIMENSIONI cm	
TOP6A 07	70x60x4	
TOP6A 08	80x60x4	
TOP6A 09	90x60x4	
TOP6A 10	100x60x4	
TOP6A 11	110x60x4	
TOP6A 12	120x60x4	
TOP6A 13	130x60x4	
TOP6A 14	140x60x4	
TOP6A 15	150x60x4	
TOP6A 16	160x60x4	
TOP6A 17	170x60x4	
TOP6A 18	180x60x4	
TOP6A 19	190x60x4	
TOP6A 20	200x60x4	
TOP6A 21	210x60x4	
TOP6A 22	220x60x4	
TOP6A 23	230x60x4	
TOP6A 24	240x60x4	
TOP6A 25	250x60x4	
TOP6A 26	260x60x4	
TOP6A 27	270x60x4	
TOP6A 28	280x60x4	
TOP6A 29	290x60x4	
TOP6A 30	300x60x4	

70

Top con alzatina Tamburrato

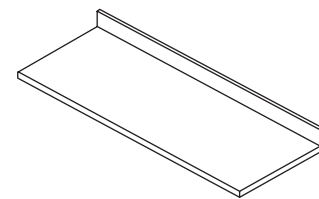

CODICE	DIMENSIONI cm	
TOP7A 07	70x70x4	
TOP7A 08	80x70x4	
TOP7A 09	90x70x4	
TOP7A 10	100x70x4	
TOP7A 11	110x70x4	
TOP7A 12	120x70x4	
TOP7A 13	130x70x4	
TOP7A 14	140x70x4	
TOP7A 15	150x70x4	
TOP7A 16	160x70x4	
TOP7A 17	170x70x4	
TOP7A 18	180x70x4	
TOP7A 19	190x70x4	
TOP7A 20	200x70x4	
TOP7A 21	210x70x4	
TOP7A 22	220x70x4	
TOP7A 23	230x70x4	
TOP7A 24	240x70x4	
TOP7A 25	250x70x4	
TOP7A 26	260x70x4	
TOP7A 27	270x70x4	
TOP7A 28	280x70x4	
TOP7A 29	290x70x4	
TOP7A 30	300x70x4	

60

Ripiano intermedio

Con omega di rinforzo

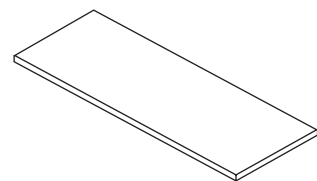

CODICE	DIMENSIONI cm
RPI6 07	70x60x4
RPI6 08	80x60x4
RPI6 09	90x60x4
RPI6 10	100x60x4
RPI6 11	110x60x4
RPI6 12	120x60x4
RPI6 13	130x60x4
RPI6 14	140x60x4
RPI6 15	150x60x4
RPI6 16	160x60x4
RPI6 17	170x60x4
RPI6 18	180x60x4
RPI6 19	190x60x4
RPI6 20	200x60x4
RPI6 21	210x60x4
RPI6 22	220x60x4
RPI6 23	230x60x4
RPI6 24	240x60x4
RPI6 25	250x60x4
RPI6 26	260x60x4
RPI6 27	270x60x4
RPI6 28	280x60x4
RPI6 29	290x60x4
RPI6 30	300x60x4

70

Ripiano intermedio

Con omega di rinforzo

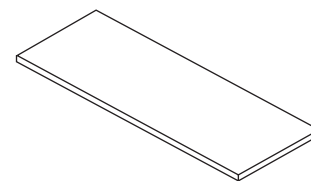

CODICE	DIMENSIONI cm
RPI7 07	70x70x4
RPI7 08	80x70x4
RPI7 09	90x70x4
RPI7 10	100x70x4
RPI7 11	110x70x4
RPI7 12	120x70x4
RPI7 13	130x70x4
RPI7 14	140x70x4
RPI7 15	150x70x4
RPI7 16	160x70x4
RPI7 17	170x70x4
RPI7 18	180x70x4
RPI7 19	190x70x4
RPI7 20	200x70x4
RPI7 21	210x70x4
RPI7 22	220x70x4
RPI7 23	230x70x4
RPI7 24	240x70x4
RPI7 25	250x70x4
RPI7 26	260x70x4
RPI7 27	270x70x4
RPI7 28	280x70x4
RPI7 29	290x70x4
RPI7 30	300x70x4

Lavorazioni

Vasca saldata a filo del piano di lavoro

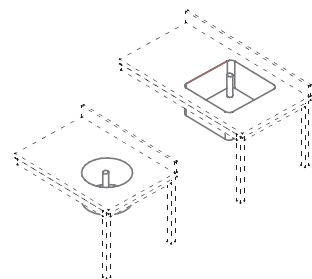

CODICE	DIMENSIONI VASCA cm	
VSS 01	40x40	
VSS 02	45x45	
VSS 03	50x50	
VSS 04	60x50	
VSS 05	ø 36	
VSS 06	ø 42	

Smussatura ad angolo

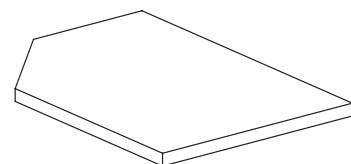

CODICE	LAVORAZIONE	
SMAT	TOP	
SMATR	TOP + RIPIANO	

Smussatura a "L"

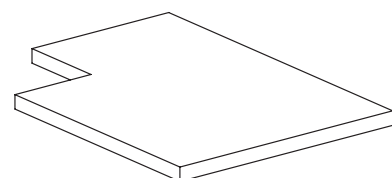

CODICE	LAVORAZIONE	
SMLT	TOP	
SMLTA	TOP CON ALZATINA	
SMLTR	TOP + RIPIANO	

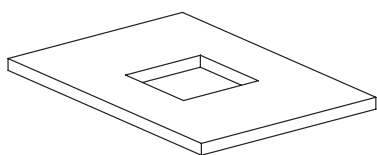

Foratura centrale

CODICE	LAVORAZIONE	
FOCE	TOP	

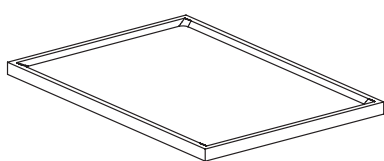

Invaso

CODICE	LAVORAZIONE	
INVA	TOP	

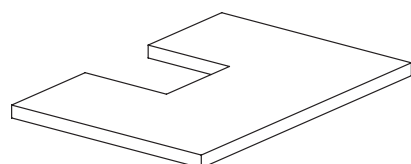

Sagomatura a "U"

CODICE	LAVORAZIONE	
SAUT	TOP	
SAUTA	TOP+ALZATINA	
SAUTR	RIPIANO	
SAUTRA	TOP+ALZATINA+RIPIANO	

Foro cernita

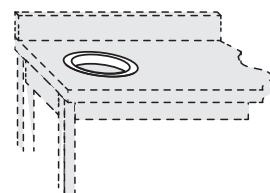

CODICE	LAVORAZIONE	
FOCE	FORO CERNITA	
ANGO	ANELLO IN GOMMA	

Alzatina

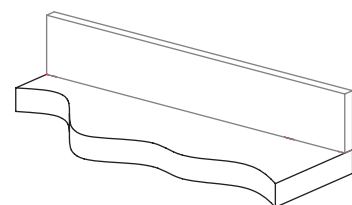

CODICE	LAVORAZIONE	
ALZ	TOP	

Kit ruote

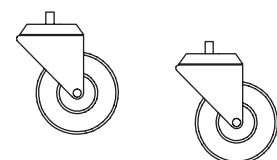

CODICE	MATERIALE/INST.	
RZPI	ZINCATA	
RAPI	ACCIAIO INOX	
RPPE	POLIPROPILENE	

PENSILI & MENSOLE



- Struttura in acciaio inox AISI 304 18/10 scotch brite anticorrosione e antitaglio;
- Struttura formata da ripiano inferiore, piano di copertura, fianchi e schienale;

60h

Pensile a giorno con ripiano



CODICE	ALTEZZA	RIP.	DIMENSIONI cm	
PGR6 06	60	1	60x40x60	
PGR6 07	60	1	70x40x60	
PGR6 08	60	1	80x40x60	
PGR6 09	60	1	90x40x60	
PGR6 10	60	1	100x40x60	
PGR6 11	60	1	110x40x60	
PGR6 12	60	1	120x40x60	
PGR6 13	60	1	130x40x60	
PGR6 14	60	1	140x40x60	
PGR6 15	60	1	150x40x60	
PGR6 16	60	1	160x40x60	
PGR6 17	60	1	170x40x60	
PGR6 18	60	1	180x40x60	
PGR6 19	60	1	190x40x60	
PGR6 20	60	1	200x40x60	

80h

Pensile a giorno con ripiano

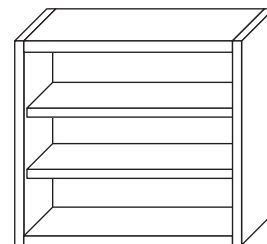

CODICE	ALTEZZA	RIP.	DIMENSIONI cm
PGR8 06	80	2	60x40x80
PGR8 07	80	2	70x40x80
PGR8 08	80	2	80x40x80
PGR8 09	80	2	90x40x80
PGR8 10	80	2	100x40x80
PGR8 11	80	2	110x40x80
PGR8 12	80	2	120x40x80
PGR8 13	80	2	130x40x80
PGR8 14	80	2	140x40x80
PGR8 15	80	2	150x40x80
PGR8 16	80	2	160x40x80
PGR8 17	80	2	170x40x80
PGR8 18	80	2	180x40x80
PGR8 19	80	2	190x40x80
PGR8 20	80	2	200x40x80

60h

Pensile a giorno con scolapiatti e ripiano asolato

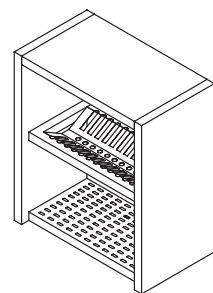

CODICE	ALTEZZA	RIP.	DIMENSIONI cm
PGSR6 06	60	1	60x40x60
PGSR6 07	60	1	70x40x60
PGSR6 08	60	1	80x40x60
PGSR6 09	60	1	90x40x60
PGSR6 10	60	1	100x40x60
PGSR6 11	60	1	110x40x60
PGSR6 12	60	1	120x40x60
PGSR6 13	60	1	130x40x60
PGSR6 14	60	1	140x40x60
PGSR6 15	60	1	150x40x60
PGSR6 16	60	1	160x40x60
PGSR6 17	60	1	170x40x60
PGSR6 18	60	1	180x40x60
PGSR6 19	60	1	190x40x60
PGSR6 20	60	1	200x40x60

80h

Pensile a giorno con scolapiatti e ripiano asolato

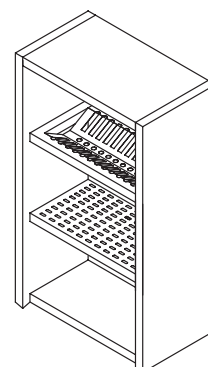

CODICE	ALTEZZA	RIP.	DIMENSIONI cm
PGSR8 06	80	2	60x40x80
PGSR8 07	80	2	70x40x80
PGSR8 08	80	2	80x40x80
PGSR8 09	80	2	90x40x80
PGSR8 10	80	2	100x40x80
PGSR8 11	80	2	110x40x80
PGSR8 12	80	2	120x40x80
PGSR8 13	80	2	130x40x80
PGSR8 14	80	2	140x40x80
PGSR8 15	80	2	150x40x80
PGSR8 16	80	2	160x40x80
PGSR8 17	80	2	170x40x80
PGSR8 18	80	2	180x40x80
PGSR8 19	80	2	190x40x80
PGSR8 20	80	2	200x40x80

60h

Pensile con ante a battente e ripiano

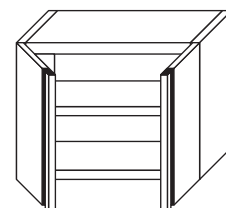

CODICE	ALTEZZA	RIP.	DIMENSIONI cm	
PBR6 06	60	1	60x40x60	
PBR6 07	60	1	70x40x60	
PBR6 08	60	1	80x40x60	
PBR6 09	60	1	90x40x60	
PBR6 10	60	1	100x40x60	
PBR6 11	60	1	110x40x60	
PBR6 12	60	1	120x40x60	

Pensile con ante scorrevoli e ripiano

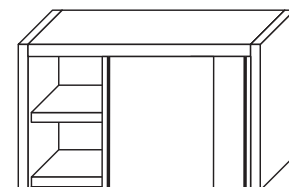

CODICE	ALTEZZA	RIP.	DIMENSIONI cm	
PBR6 10	60	1	100x40x60	
PBR6 11	60	1	110x40x60	
PBR6 12	60	1	120x40x60	
PBR6 13	60	1	130x40x60	
PBR6 14	60	1	140x40x60	
PBR6 15	60	1	150x40x60	
PBR6 16	60	1	160x40x60	
PBR6 17	60	1	170x40x60	
PBR6 18	60	1	180x40x60	
PBR6 19	60	1	190x40x60	
PBR6 20	60	1	200x40x60	

80h

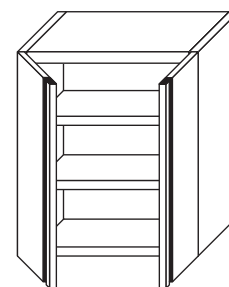

Pensile con ante a battente e ripiano

CODICE	ALTEZZA	RIP.	DIMENSIONI cm
PBR8 06	80	2	60x40x80
PBR8 07	80	2	70x40x80
PBR8 08	80	2	80x40x80
PBR8 09	80	2	90x40x80
PBR8 10	80	2	100x40x80
PBR8 11	80	2	110x40x80
PBR8 12	80	2	120x40x80

Pensile con ante scorrevoli e ripiano

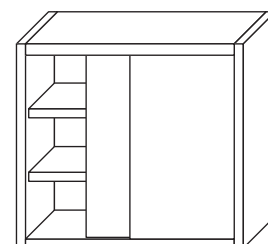

CODICE	ALTEZZA	RIP.	DIMENSIONI cm
PBR8 10	80	2	100x40x80
PBR8 11	80	2	110x40x80
PBR8 12	80	2	120x40x80
PBR8 13	80	2	130x40x80
PBR8 14	80	2	140x40x80
PBR8 15	80	2	150x40x80
PBR8 16	80	2	160x40x80
PBR8 17	80	2	170x40x80
PBR8 18	80	2	180x40x80
PBR8 19	80	2	190x40x80
PBR8 20	80	2	200x40x80

60h

Pensile con ante a battente, scolapiatti e ripiano asolato

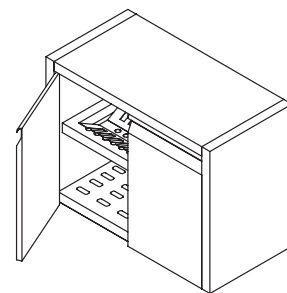

CODICE	ALTEZZA	RIP.	DIMENSIONI cm
PBSR6 06	60	1	60x40x60
PBSR6 07	60	1	70x40x60
PBSR6 08	60	1	80x40x60
PBSR6 09	60	1	90x40x60
PBSR6 10	60	1	100x40x60
PBSR6 11	60	1	110x40x60
PBSR6 12	60	1	120x40x60

Pensile con ante scorrevoli, scolapiatti e ripiano asolato

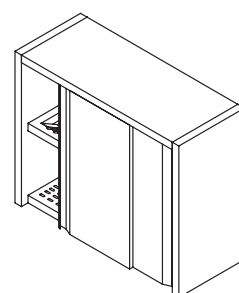

CODICE	ALTEZZA	RIP.	DIMENSIONI cm
PSSR6 10	60	1	100x40x60
PSSR6 11	60	1	110x40x60
PSSR6 12	60	1	120x40x60
PSSR6 13	60	1	130x40x60
PSSR6 14	60	1	140x40x60
PSSR6 15	60	1	150x40x60
PSSR6 16	60	1	160x40x60
PSSR6 17	60	1	170x40x60
PSSR6 18	60	1	180x40x60
PSSR6 19	60	1	190x40x60
PSSR6 20	60	1	200x40x60

80h

Pensile con ante a battente, scolapiatti e ripiano asolato

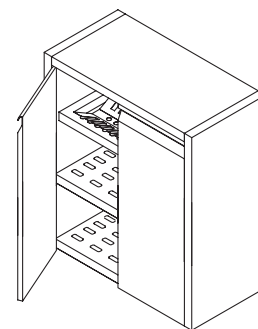

CODICE	ALTEZZA	RIP.	DIMENSIONI cm
PBSR8 06	80	2	60x40x80
PBSR8 07	80	2	70x40x80
PBSR8 08	80	2	80x40x80
PBSR8 09	80	2	90x40x80
PBSR8 10	80	2	100x40x80
PBSR8 11	80	2	110x40x80
PBSR8 12	80	2	120x40x80

Pensile con ante scorrevoli, scolapiatti e ripiano asolato

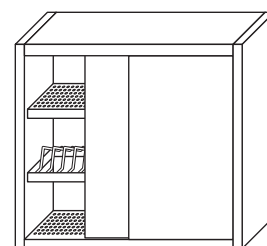

CODICE	ALTEZZA	RIP.	DIMENSIONI cm
PSSR8 10	80	2	100x40x80
PSSR8 11	80	2	110x40x80
PSSR8 12	80	2	120x40x80
PSSR8 13	80	2	130x40x80
PSSR8 14	80	2	140x40x80
PSSR8 15	80	2	150x40x80
PSSR8 16	80	2	160x40x80
PSSR8 17	80	2	170x40x80
PSSR8 18	80	2	180x40x80
PSSR8 19	80	2	190x40x80
PSSR8 20	80	2	200x40x80

60h

Pensile con ante scorrevoli e ripiani asolati

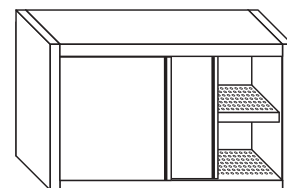

CODICE	ALTEZZA	RIP.	DIMENSIONI cm	
PSRA6 10	60	1	100x40x60	
PSRA6 11	60	1	110x40x60	
PSRA6 12	60	1	120x40x60	
PSRA6 13	60	1	130x40x60	
PSRA6 14	60	1	140x40x60	
PSRA6 15	60	1	150x40x60	
PSRA6 16	60	1	160x40x60	
PSRA6 17	60	1	170x40x60	
PSRA6 18	60	1	180x40x60	
PSRA6 19	60	1	190x40x60	
PSRA6 20	60	1	200x40x60	

80h

Pensile con ante scorrevoli e ripiani asolati

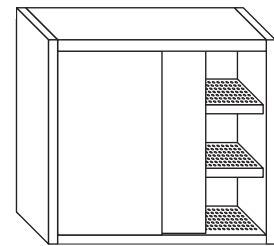

CODICE	ALTEZZA	RIP.	DIMENSIONI cm	
PSRA8 10	80	2	100x40x80	
PSRA8 11	80	2	110x40x80	
PSRA8 12	80	2	120x40x80	
PSRA8 13	80	2	130x40x80	
PSRA8 14	80	2	140x40x80	
PSRA8 15	80	2	150x40x80	
PSRA8 16	80	2	160x40x80	
PSRA8 17	80	2	170x40x80	
PSRA8 18	80	2	180x40x80	
PSRA8 19	80	2	190x40x80	
PSRA8 20	80	2	200x40x80	

Mensola con reggimensole saldate

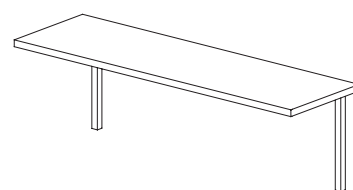

CODICE	PROF.	DIMENSIONI cm
MRS3 10	30	100x30
MRS3 11	30	110x30
MRS3 12	30	120x30
MRS3 13	30	130x30
MRS3 14	30	140x30
MRS3 15	30	150x30
MRS3 16	30	160x30
MRS3 17	30	170x30
MRS3 18	30	180x30
MRS3 19	30	190x30
MRS3 20	30	200x30
MRS4 10	40	100x40
MRS4 11	40	110x40
MRS4 12	40	120x40
MRS4 13	40	130x40
MRS4 14	40	140x40
MRS4 15	40	150x40
MRS4 16	40	160x40
MRS4 17	40	170x40
MRS4 18	40	180x40
MRS4 19	40	190x40
MRS4 20	40	200x40

Mensola con reggimensole saldate

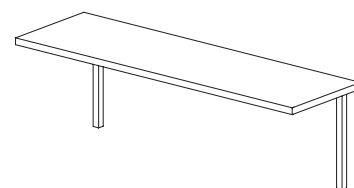

CODICE	PROF.	DIMENSIONI cm	
MRS5 10	50	100x50	
MRS5 11	50	110x50	
MRS5 12	50	120x50	
MRS5 13	50	130x50	
MRS5 14	50	140x50	
MRS5 15	50	150x50	
MRS5 16	50	160x50	
MRS5 17	50	170x50	
MRS5 18	50	180x50	
MRS5 19	50	190x50	
MRS5 20	50	200x50	

Mensola con staffa integrata

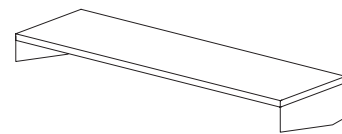

CODICE	PROF.	DIMENSIONI cm
MSI3 10	30	100x30
MSI3 11	30	110x30
MSI3 12	30	120x30
MSI3 13	30	130x30
MSI3 14	30	140x30
MSI3 15	30	150x30
MSI3 16	30	160x30
MSI3 17	30	170x30
MSI3 18	30	180x30
MSI3 19	30	190x30
MSI3 20	30	200x30
MSI4 10	40	100x40
MSI4 11	40	110x40
MSI4 12	40	120x40
MSI4 13	40	130x40
MSI4 14	40	140x40
MSI4 15	40	150x40
MSI4 16	40	160x40
MSI4 17	40	170x40
MSI4 18	40	180x40
MSI4 19	40	190x40
MSI4 20	40	200x40

SCAFFALI & ARMADI



- Struttura in acciaio inox AISI 304 18/10 scotch brite anticorrosione e antitaglio;
- Struttura formata da ripiano inferiore, piano di copertura, fianchi e schienale;
- È possibile aggiungere ulteriori ripiani con omega di rinforzo saldato;

Scaffale con 4 ripiani lisci rinforzati e saldati

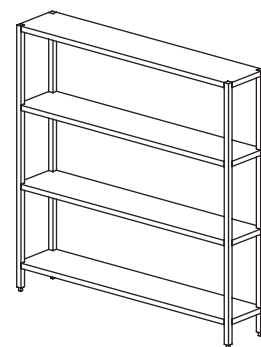

CODICE	PROF.	DIMENSIONI cm
SAL4 10	40	100x40x200
SAL4 11	40	110x40x200
SAL4 12	40	120x40x200
SAL4 13	40	130x40x200
SAL4 14	40	140x40x200
SAL4 15	40	150x40x200
SAL4 16	40	160x40x200
SAL4 17	40	170x40x200
SAL4 18	40	180x40x200
SAL5 10	50	100x50x200
SAL5 11	50	110x50x200
SAL5 12	50	120x50x200
SAL5 13	50	130x50x200
SAL5 14	50	140x50x200
SAL5 15	50	150x50x200
SAL5 16	50	160x50x200
SAL5 17	50	170x50x200
SAL5 18	50	180x50x200

Scaffale con 4 ripiani lisci rinforzati e saldati

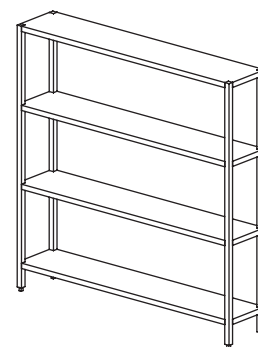

CODICE	PROF.	DIMENSIONI cm
SAL6 10	60	100x60x200
SAL6 11	60	110x60x200
SAL6 12	60	120x60x200
SAL6 13	60	130x60x200
SAL6 14	60	140x60x200
SAL6 15	60	150x60x200
SAL6 16	60	160x60x200
SAL6 17	60	170x60x200
SAL6 18	60	180x60x200
SAL7 10	70	100x70x200
SAL7 11	70	110x70x200
SAL7 12	70	120x70x200
SAL7 13	70	130x70x200
SAL7 14	70	140x70x200
SAL7 15	70	150x70x200
SAL7 16	70	160x70x200
SAL7 17	70	170x70x200
SAL7 18	70	180x70x200

Scaffale aperto con 4 ripiani forati rinforzati e saldati

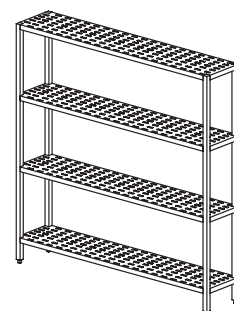

CODICE	PROF.	DIMENSIONI cm
SAS4 10	40	100x40x200
SAS4 11	40	110x40x200
SAS4 12	40	120x40x200
SAS4 13	40	130x40x200
SAS4 14	40	140x40x200
SAS4 15	40	150x40x200
SAS4 16	40	160x40x200
SAS4 17	40	170x40x200
SAS4 18	40	180x40x200
SAS5 10	50	100x50x200
SAS5 11	50	110x50x200
SAS5 12	50	120x50x200
SAS5 13	50	130x50x200
SAS5 14	50	140x50x200
SAS5 15	50	150x50x200
SAS5 16	50	160x50x200
SAS5 17	50	170x50x200
SAS5 18	50	180x50x200

Scaffale aperto con 4 ripiani forati rinforzati e saldati

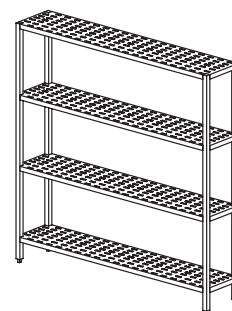

CODICE	PROF.	DIMENSIONI cm	
SAS6 10	60	100x60x200	
SAS6 11	60	110x60x200	
SAS6 12	60	120x60x200	
SAS6 13	60	130x60x200	
SAS6 14	60	140x60x200	
SAS6 15	60	150x60x200	
SAS6 16	60	160x60x200	
SAS6 17	60	170x60x200	
SAS6 18	60	180x60x200	
SAS7 10	70	100x70x200	
SAS7 11	70	110x70x200	
SAS7 12	70	120x70x200	
SAS7 13	70	130x70x200	
SAS7 14	70	140x70x200	
SAS7 15	70	150x70x200	
SAS7 16	70	160x70x200	
SAS7 17	70	170x70x200	
SAS7 18	70	180x70x200	

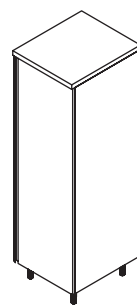

Armadio con ante a battente e 3 ripiani regolabili

CODICE	PROF.	ALTEZZA	DIMENSIONI cm
AAB5 06	50	170	60x50x170
AAB5 07	50	170	70x50x170
PAAB5 08	50	170	80x50x170
AAB5 09	50	170	90x50x170
AAB5 10	50	170	100x50x170
AAB5 11	50	170	110x50x170
AAB5 12	50	170	120x50x170
AAB7 06	70	200	60x70x200
AAB7 07	70	200	70x70x200
AAB7 08	70	200	80x70x200
AAB7 09	70	200	90x70x200
AAB7 10	70	200	100x70x200
AAB7 11	70	200	110x70x200
AAB7 12	70	200	120x70x200

Armadio con ante scorrevoli e 3 ripiani regolabili

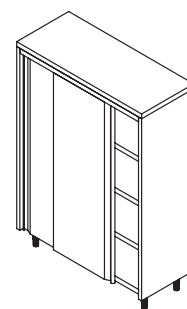

CODICE	PROF.	ALTEZZA	DIMENSIONI cm
AAS5 12	50	170	120x50x170
AAS5 13	50	170	130x50x170
AAS5 14	50	170	140x50x170
AAS5 15	50	170	150x50x170
AAS5 16	50	170	160x50x170
AAS5 17	50	170	170x50x170
AAS5 18	50	170	180x50x170
AAS5 19	50	170	190x50x170
AAS5 20	50	170	200x50x170
AAS7 12	70	200	120x70x200
AAS7 13	70	200	130x70x200
AAS7 14	70	200	140x70x200
AAS7 15	70	200	150x70x200
AAS7 16	70	200	160x70x200
AAS7 17	70	200	170x70x200
AAS7 18	70	200	180x70x200
AAS7 19	70	200	190x70x200
AAS7 20	70	200	200x70x200

Armadi sovrapposti con ante scorrevoli e ripiani regolabili

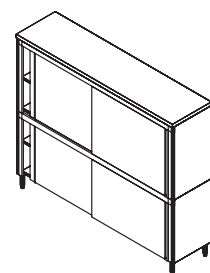

CODICE	PROF.	ALTEZZA	DIMENSIONI cm
ASS5 12	50	170	120x50x170
ASS5 13	50	170	130x50x170
ASS5 14	50	170	140x50x170
ASS5 15	50	170	150x50x170
ASS5 16	50	170	160x50x170
ASS5 17	50	170	170x50x170
ASS5 18	50	170	180x50x170
ASS5 19	50	170	190x50x170
ASS5 20	50	170	200x50x170
ASS7 12	70	200	120x70x200
ASS7 13	70	200	130x70x200
ASS7 14	70	200	140x70x200
ASS7 15	70	200	150x70x200
ASS7 16	70	200	160x70x200
ASS7 17	70	200	170x70x200
ASS7 18	70	200	180x70x200
ASS7 19	70	200	190x70x200
ASS7 20	70	200	200x70x200

LAVELLI



- Struttura in acciaio inox AISI 304 18/10 scotch brite anticorrosione e antitaglio;
- Gambe con tubolare quadro 40x40 scotch brite con piedini regolabili;
- Top con alzatina paraspruzzi con vasca inclinata verso lo scarico;
- Vasca con fondo insonorizzato;
- Dotazione standard: piletta di scarico e troppopieno;
- Bordo piano mm 40;

SPECIFICHE TECNICHE

LAVELLI

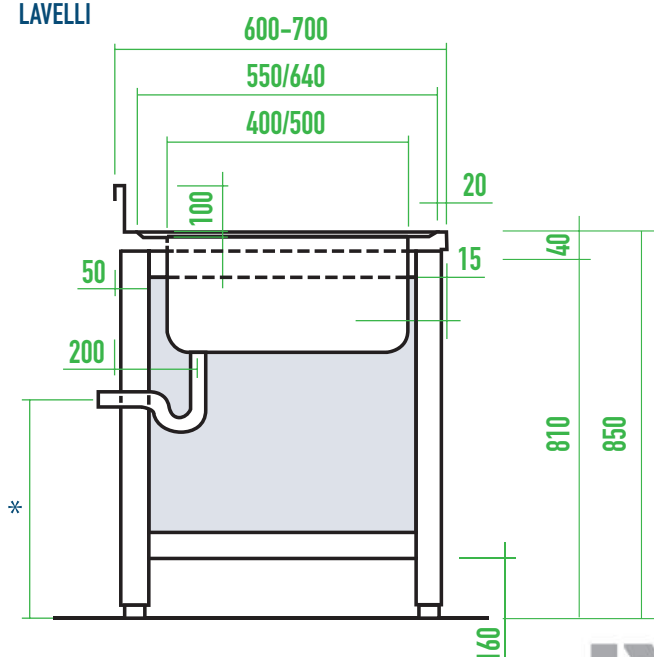

* 40 PER SIFONE SINGOLO
35 PER SIFONE DOPPIO
29 PER LAVAPENTOLE

Lavello a giorno

1 vasca

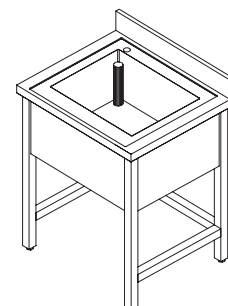

CODICE	PROF.	DIM. MOBILE	DIM. VASCA
LAG6 06	60	60x60x85	50x40x30
LAG6 07	60	70x60x85	50x40x30
LAG6 08	60	80x60x85	50x40x30
LAG6 09	60	90x60x85	50x40x30
LAG7 06	70	60x70x85	40x50x30
LAG7 07	70	70x70x85	50x50x30
LAG7 08	70	80x70x85	60x50x30
LAG7 09	70	90x70x85	60x50x30

Lavello a giorno

2 vasche

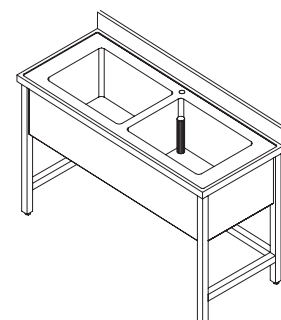

CODICE	PROF.	DIM. MOBILE	DIM. VASCA
LAG6 2V 10	60	100x60x85	40x40x30
LAG6 2V 12	60	120x60x85	50x40x30
LAG6 2V 13	60	130x60x85	50x40x30
LAG6 2V 14	60	140x60x85	50x40x30
LAG6 2V 16	60	160x60x85	60x50x30
LAG7 2V 10	70	100x70x85	40x50x30
LAG7 2V 12	70	120x70x85	50x50x30
LAG7 2V 13	70	130x70x85	50x50x30
LAG7 2V 14	70	140x70x85	60x50x30
LAG7 2V 15	70	150x70x85	60x50x30
LAG7 2V 16	70	160x70x85	60x50x30

Lavello a giorno

1 vasca, gocciolatoio a destra

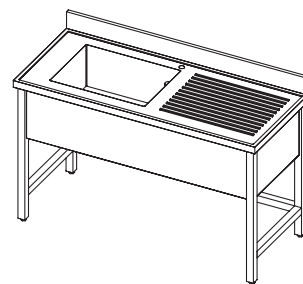

CODICE	PROF.	DIM. MOBILE	DIM. VASCA
LAG6 1VGDX 10	60	100x60x85	50x40x30
LAG6 1VGDX 11	60	110x60x85	50x40x30
LAG6 2VGDX 12	60	120x60x85	50x40x30
LAG6 1VGDX 13	60	130x60x85	50x40x30
LAG6 1VGDX 14	60	140x60x85	50x40x30
LAG7 1VGDX 10	70	100x70x85	50x50x30
LAG7 1VGDX 11	70	110x70x85	50x50x30
LAG7 1VGDX 12	70	120x70x85	50x50x30
LAG7 1VGDX 13	70	130x70x85	50x50x30
LAG7 1VGDX 14	70	140x70x85	60x50x30

Lavello a giorno

1 vasca, gocciolatoio a sinistra

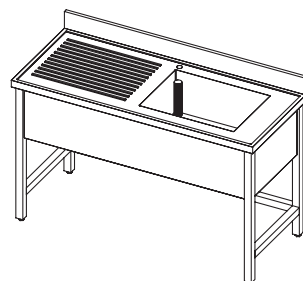

CODICE	PROF.	DIM. MOBILE	DIM. VASCA
LAG6 1VGSX 10	60	100x60x85	50x40x30
LAG6 1VGSX 11	60	110x60x85	50x40x30
LAG6 2VGSX 12	60	120x60x85	50x40x30
LAG6 1VGSX 13	60	130x60x85	50x40x30
LAG6 1VGSX 14	60	140x60x85	50x40x30
LAG7 1VGSX 10	70	100x70x85	50x50x30
LAG7 1VGSX 11	70	110x70x85	50x50x30
LAG7 1VGSX 12	70	120x70x85	50x50x30
LAG7 1VGSX 13	70	130x70x85	50x50x30
LAG7 1VGSX 14	70	140x70x85	60x50x30

Lavello a giorno

2 vasche, gocciolatoio a destra

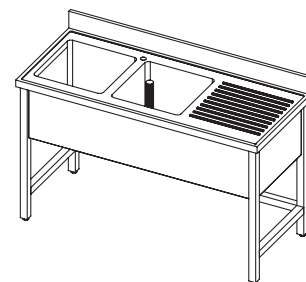

CODICE	PROF.	DIM. MOBILE	DIM. VASCA	
LAG6 2VGDX 14	60	140x60x85	40x40x30	
LAG6 2VGDX 15	60	150x60x85	40x40x30	
LAG6 2VGDX 16	60	160x60x85	50x40x30	
LAG6 2VGDX 17	60	170x60x85	50x40x30	
LAG6 2VGDX 18	60	180x60x85	50x40x30	
LAG6 2VGDX 19	60	190x60x85	50x40x30	
LAG6 2VGDX 20	60	200x60x85	50x40x30	
LAG7 2VGDX 14	70	140x70x85	40x50x30	
LAG7 2VGDX 15	70	150x70x85	40x50x30	
LAG7 2VGDX 16	70	160x70x85	40x50x30	
LAG7 2VGDX 17	70	170x70x85	40x50x30	
LAG7 2VGDX 18	70	180x70x85	50x50x30	
LAG7 2VGDX 19	70	190x70x85	50x50x30	
LAG7 2VGDX 20	70	200x70x85	60x50x30	

Lavello a giorno

2 vasche, gocciolatoio a sinistra

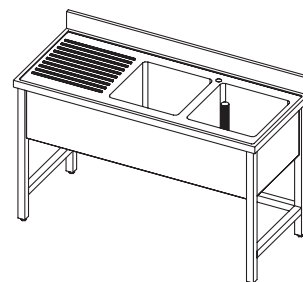

CODICE	PROF.	DIM. MOBILE	DIM. VASCA
LAG6 2VGSX 14	60	140x60x85	40x40x30
LAG6 2VGSX 15	60	150x60x85	40x40x30
LAG6 2VGSX 16	60	160x60x85	50x40x30
LAG6 2VGSX 17	60	170x60x85	50x40x30
LAG6 2VGSX 18	60	180x60x85	50x40x30
LAG6 2VGSX 19	60	190x60x85	50x40x30
LAG6 2VGSX 20	60	200x60x85	50x40x30
LAG7 2VGSX 14	70	140x70x85	40x50x30
LAG7 2VGSX 15	70	150x70x85	40x50x30
LAG7 2VGSX 16	70	160x70x85	40x50x30
LAG7 2VGSX 17	70	170x70x85	40x50x30
LAG7 2VGSX 18	70	180x70x85	50x50x30
LAG7 2VGSX 19	70	190x70x85	50x50x30
LAG7 2VGSX 20	70	200x70x85	60x50x30

Lavello a giorno

2 vasche, 2gocciolatoi

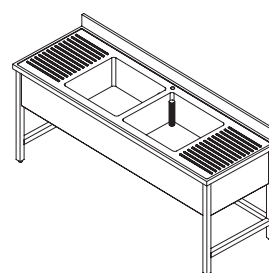

CODICE	PROF.	DIM. MOBILE	DIM. VASCA
LAG7 2V2G 19	70	190x70x85	40x50x30
LAG7 2V2G 20	70	200x70x85	40x50x30
LAG7 2V2G 21	70	210x70x85	50x50x30
LAG7 2V2G 22	70	220x70x85	50x50x30
LAG7 2V2G 24	70	240x70x85	60x50x30
LAG7 2V2G 25	70	250x70x85	60x50x30
LAG7 2V2G 26	70	260x70x85	60x50x30

Lavello a giorno con ripiano

1 vasca

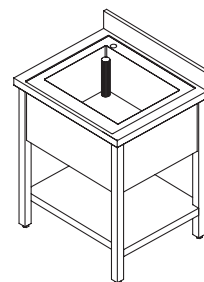

CODICE	PROF.	DIM. MOBILE	DIM. VASCA
LAR6 06	60	60x60x85	50x40x30
LAR6 07	60	70x60x85	50x40x30
LAR6 08	60	80x60x85	50x40x30
LAR6 09	60	90x60x85	50x40x30
LAR7 06	70	60x70x85	40x50x30
LAR7 07	70	70x70x85	50x50x30
LAR7 08	70	80x70x85	60x50x30
LAR7 09	70	90x70x85	60x50x30

Lavello a giorno con ripiano

2 vasche

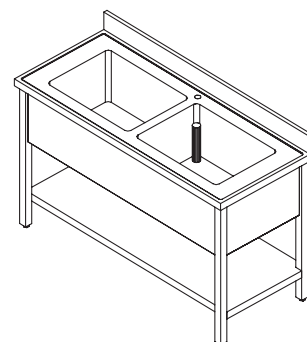

CODICE	PROF.	DIM. MOBILE	DIM. VASCA
LAR6 2V 10	60	100x60x85	40x40x30
LAR6 2V 12	60	120x60x85	50x40x30
LAR6 2V 13	60	130x60x85	50x40x30
LAR6 2V 14	60	140x60x85	50x40x30
LAR6 2V 16	60	160x60x85	60x50x30
LAR7 2V 10	70	100x70x85	40x50x30
LAR7 2V 12	70	120x70x85	50x50x30
LAR7 2V 13	70	130x70x85	50x50x30
LAR7 2V 14	70	140x70x85	60x50x30
LAR7 2V 15	70	150x70x85	60x50x30
LAG7 2V 16	70	160x70x85	60x50x30

Lavello a giorno con ripiano

1 vasca, gocciolatoio a destra

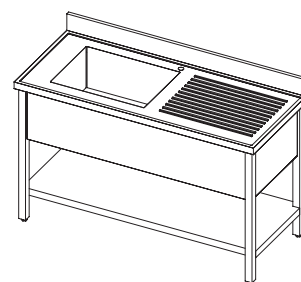

CODICE	PROF.	DIM. MOBILE	DIM. VASCA
LAR6 1VGDX 10	60	100x60x85	50x40x30
LAR6 1VGDX 11	60	110x60x85	50x40x30
LAR6 2VGDX 12	60	120x60x85	50x40x30
LAR6 1VGDX 13	60	130x60x85	50x40x30
LAR6 1VGDX 14	60	140x60x85	50x40x30
LAR7 1VGDX 10	70	100x70x85	50x50x30
LAR7 1VGDX 11	70	110x70x85	50x50x30
LAR7 1VGDX 12	70	120x70x85	50x50x30
LAR7 1VGDX 13	70	130x70x85	50x50x30
LAR7 1VGDX 14	70	140x70x85	60x50x30

Lavello a giorno con ripiano

1 vasca, gocciolatoio a sinistra

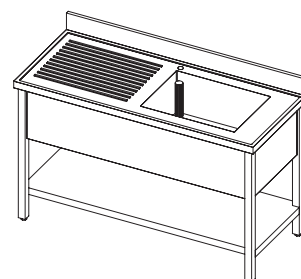

CODICE	PROF.	DIM. MOBILE	DIM. VASCA
LAR6 1VGSX 10	60	100x60x85	50x40x30
LAR6 1VGSX 11	60	110x60x85	50x40x30
LAR6 2VGSX 12	60	120x60x85	50x40x30
LAR6 1VGSX 13	60	130x60x85	50x40x30
LAR6 1VGSX 14	60	140x60x85	50x40x30
LAR7 1VGSX 10	70	100x70x85	50x50x30
LAR7 1VGSX 11	70	110x70x85	50x50x30
LAR7 1VGSX 12	70	120x70x85	50x50x30
LAR7 1VGSX 13	70	130x70x85	50x50x30
LAR7 1VGSX 14	70	140x70x85	60x50x30

Lavello a giorno con ripiano

2 vasche, gocciolatoio a destra

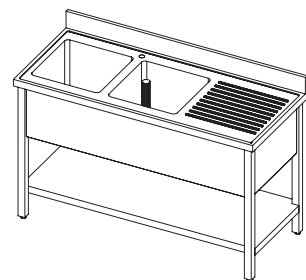

CODICE	PROF.	DIM. MOBILE	DIM. VASCA	
LAR6 2VGDX 14	60	140x60x85	40x40x30	
LAR6 2VGDX 15	60	150x60x85	40x40x30	
LAR6 2VGDX 16	60	160x60x85	50x40x30	
LAR6 2VGDX 17	60	170x60x85	50x40x30	
LAR6 2VGDX 18	60	180x60x85	50x40x30	
LAR6 2VGDX 19	60	190x60x85	50x40x30	
LAR6 2VGDX 20	60	200x60x85	50x40x30	
LAR7 2VGDX 14	70	140x70x85	40x50x30	
LAR7 2VGDX 15	70	150x70x85	40x50x30	
LAR7 2VGDX 16	70	160x70x85	40x50x30	
LAR7 2VGDX 17	70	170x70x85	40x50x30	
LAR7 2VGDX 18	70	180x70x85	50x50x30	
LAR7 2VGDX 19	70	190x70x85	50x50x30	
LAR7 2VGDX 20	70	200x70x85	60x50x30	

Lavello a giorno con ripiano

2 vasche, gocciolatoio a sinistra

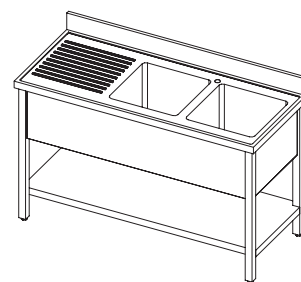

CODICE	PROF.	DIM. MOBILE	DIM. VASCA	
LAR6 2VGSX 14	60	140x60x85	40x40x30	
LAR6 2VGSX 15	60	150x60x85	40x40x30	
LAR6 2VGSX 16	60	160x60x85	50x40x30	
LAR6 2VGSX 17	60	170x60x85	50x40x30	
LAR6 2VGSX 18	60	180x60x85	50x40x30	
LAR6 2VGSX 19	60	190x60x85	50x40x30	
LAR6 2VGSX 20	60	200x60x85	50x40x30	
LAR7 2VGSX 14	70	140x70x85	40x50x30	
LAR7 2VGSX 15	70	150x70x85	40x50x30	
LAR7 2VGSX 16	70	160x70x85	40x50x30	
LAR7 2VGSX 17	70	170x70x85	40x50x30	
LAR7 2VGSX 18	70	180x70x85	50x50x30	
LAR7 2VGSX 19	70	190x70x85	50x50x30	
LAR7 2VGSX 20	70	200x70x85	60x50x30	

Lavello a giorno con ripiano

2 vasche, 2gocciolatoi

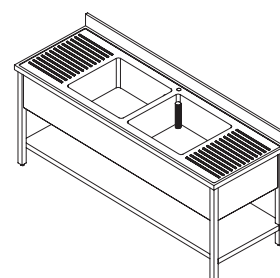

CODICE	PROF.	DIM. MOBILE	DIM. VASCA	
LAR7 2V2G 19	70	190x70x85	40x50x30	
LAR7 2V2G 20	70	200x70x85	40x50x30	
LAR7 2V2G 21	70	210x70x85	50x50x30	
LAR7 2V2G 22	70	220x70x85	50x50x30	
LAR7 2V2G 24	70	240x70x85	60x50x30	
LAR7 2V2G 25	70	250x70x85	60x50x30	
LAR7 2V2G 26	70	260x70x85	60x50x30	

Lavello armadiato con ante scorrevoli

2 vasche

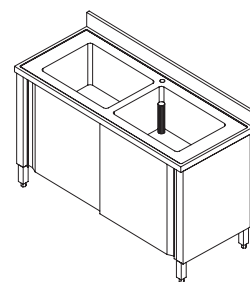

CODICE	PROF.	DIM. MOBILE	DIM. VASCA
LMS6 2V 10	60	100x60x85	40x40x30
LMS6 2V 12	60	120x60x85	50x40x30
LMS6 2V 13	60	130x60x85	50x40x30
LMS6 2V 14	60	140x60x85	50x50x30
LMS6 2V 15	60	150x60x85	60x50x30
LMS6 2V 16	60	160x60x85	60x50x30
LMS7 2V 10	70	100x70x85	40x50x30
LMS7 2V 12	70	120x70x85	50x50x30
LMS7 2V 13	70	130x70x85	50x50x30
LMS7 2V 14	70	140x70x85	60x50x30
LMS7 2V 15	70	150x70x85	60x50x30
LMS7 2V 16	70	160x70x85	60x50x30

Lavello armadiato con ante scorrevoli

2 vasche 2 gocciolatoi

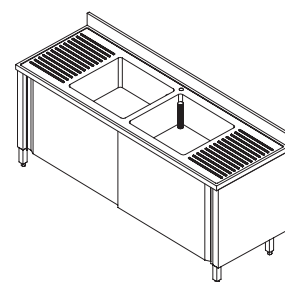

CODICE	PROF.	DIM. MOBILE	DIM. VASCA
LMS7 2V2G 19	70	190x70x85	40x50x30
LMS7 2V2G 20	70	200x70x85	40x50x30
LMS7 2V2G 21	70	210x70x85	50x50x30
LMS7 2V2G 22	70	220x70x85	50x50x30
LMS7 2V2G 24	70	240x70x85	60x50x30
LMS7 2V2G 25	70	250x70x85	60x50x30
LMS7 2V2G 26	70	260x70x85	60x50x30

Lavello armadiato con ante scorrevoli

1 vasca, gocciolatoio a destra

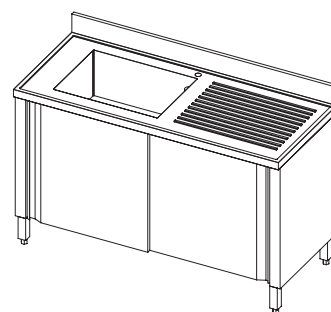

CODICE	PROF.	DIM. MOBILE	DIM. VASCA
LMS6 1VGDX 10	60	100x60x85	50x40x30
LMS6 1VGDX 11	60	110x60x85	50x40x30
LMS6 2VGDX 12	60	120x60x85	50x40x30
LMS6 1VGDX 13	60	130x60x85	50x40x30
LMS6 1VGDX 14	60	140x60x85	50x40x30
LMS7 1VGDX 10	70	100x70x85	50x50x30
LMS7 1VGDX 11	70	110x70x85	50x50x30
LMS7 1VGDX 12	70	120x70x85	50x50x30
LMS7 1VGDX 13	70	130x70x85	50x50x30
LMS7 1VGDX 14	70	140x70x85	50x50x30

Lavello armadiato con ante scorrevoli

1 vasca, gocciolatoio a sinistra

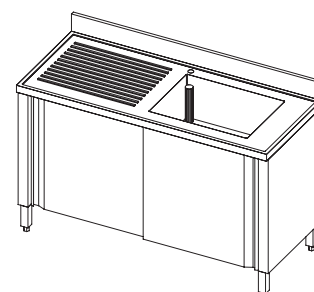

CODICE	PROF.	DIM. MOBILE	DIM. VASCA
LMS6 1VGSX 10	60	100x60x85	50x40x30
LMS6 1VGSX 11	60	110x60x85	50x40x30
LMS6 2VGSX 12	60	120x60x85	50x40x30
LMS6 1VGSX 13	60	130x60x85	50x40x30
LMS6 1VGSX 14	60	140x60x85	50x40x30
LMS7 1VGSX 10	70	100x70x85	50x50x30
LMS7 1VGSX 11	70	110x70x85	50x50x30
LMS7 1VGSX 12	70	120x70x85	50x50x30
LMS7 1VGSX 13	70	130x70x85	50x50x30
LMS7 1VGSX 14	70	140x70x85	50x50x30

Lavello armadiato con ante scorrevoli

2 vasche, gocciolatoio a destra

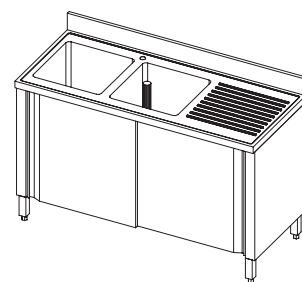

CODICE	PROF.	DIM. MOBILE	DIM. VASCA	
LMS6 2VGDX 14	60	140x60x85	40x40x30	
LMS6 2VGDX 15	60	150x60x85	40x40x30	
LMS6 2VGDX 16	60	160x60x85	50x40x30	
LMS6 2VGDX 17	60	170x60x85	50x40x30	
LMS6 2VGDX 18	60	180x60x85	50x40x30	
LMS6 2VGDX 19	60	190x60x85	50x40x30	
LMS6 2VGDX 20	60	200x60x85	50x40x30	
LMS7 2VGDX 14	70	140x70x85	40x50x30	
LMS7 2VGDX 15	70	150x70x85	40x50x30	
LMS7 2VGDX 16	70	160x70x85	40x50x30	
LMS7 2VGDX 17	70	170x70x85	40x50x30	
LMS7 2VGDX 18	70	180x70x85	50x50x30	
LMS7 2VGDX 19	70	190x70x85	50x50x30	
LMS7 2VGDX 20	70	200x70x85	60x50x30	

Lavello armadiato con ante scorrevoli

2 vasche, gocciolatoio a sinistra

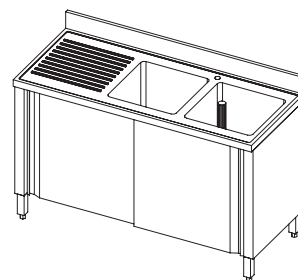

CODICE	PROF.	DIM. MOBILE	DIM. VASCA	
LMS6 2VGSX 14	60	140x60x85	40x40x30	
LMS6 2VGSX 15	60	150x60x85	40x40x30	
LMS6 2VGSX 16	60	160x60x85	50x40x30	
LMS6 2VGSX 17	60	170x60x85	50x40x30	
LMS6 2VGSX 18	60	180x60x85	50x40x30	
LMS6 2VGSX 19	60	190x60x85	50x40x30	
LMS6 2VGSX 20	60	200x60x85	50x40x30	
LMS7 2VGSX 14	70	140x70x85	40x50x30	
LMS7 2VGSX 15	70	150x70x85	40x50x30	
LMS7 2VGSX 16	70	160x70x85	40x50x30	
LMS7 2VGSX 17	70	170x70x85	40x50x30	
LMS7 2VGSX 18	70	180x70x85	50x50x30	
LMS7 2VGSX 19	70	190x70x85	50x50x30	
LMS7 2VGSX 20	70	200x70x85	60x50x30	

Lavello armadiato con ante battenti

1 vasca

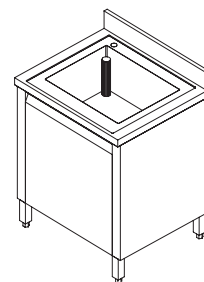

CODICE	PROF.	DIM. MOBILE	DIM. VASCA
LMB6 1V 06	60	60x60x85	50x40x30
LMB6 1V 07	60	70x60x85	50x40x30
LMB6 1V 08	60	80x60x85	50x40x30
LMB6 1V 09	60	90x60x85	50x40x30
LMB7 1V 06	70	60x70x85	40x50x30
LMB7 1V 07	70	70x70x85	50x50x30
LMB7 1V 08	70	80x70x85	60x50x30
LMB7 1V 09	70	90x70x85	60x50x30

Lavello armadiato con ante battenti

2 vasche

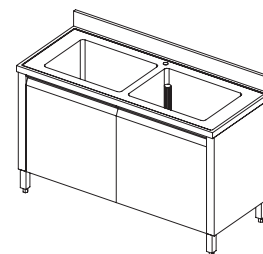

CODICE	PROF.	DIM. MOBILE	DIM. VASCA
LMB6 2V 10	60	100x60x85	40x40x30
LMB6 2V 12	60	120x60x85	50x40x30
LMB7 2V 10	70	100x70x85	40x50x30
LMB7 2V 12	70	120x70x85	50x50x30

Lavello armadiato con ante battenti

1 vasca, gocciolatoio a destra

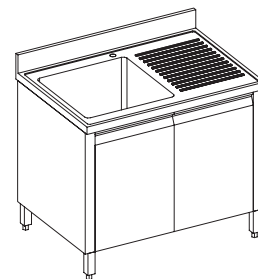

CODICE	PROF.	DIM. MOBILE	DIM. VASCA	
LMB6 1VGDX 10	60	100x60x85	50x40x30	
LMB6 1VGDX 12	60	120x60x85	50x40x30	
LMB7 1VGDX 10	70	100x70x85	50x50x30	
LMB7 1VGDX 12	70	120x70x85	50x50x30	

Lavello armadiato con ante battenti

1 vasca, gocciolatoio a sinistra

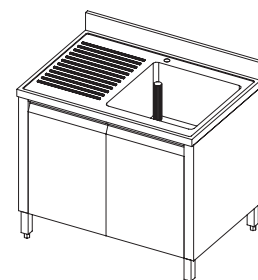

CODICE	PROF.	DIM. MOBILE	DIM. VASCA	
LMB6 1VGSX 10	60	100x60x85	50x40x30	
LMB6 1VGSX 12	60	120x60x85	50x40x30	
LMB7 1VGSX 10	70	100x70x85	50x50x30	
LMB7 1VGSX 12	70	120x70x85	50x50x30	

Lavello lavastoviglie con ripiano

1 vasca, gocciolatoio a destra

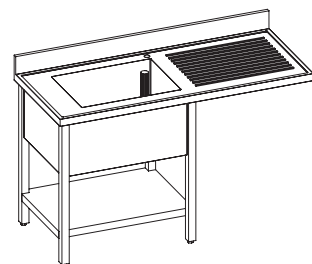

CODICE	PROF.	DIM. MOBILE	DIM. VASCA	
LSR7 1VGDX 11	70	110x70x85	40x50x30	
LSR7 1VGDX 12	70	120x70x85	50x50x30	
LSR7 1VGDX 13	70	130x70x85	50x50x30	
LSR7 1VGDX 14	70	140x70x85	60x50x30	

Lavello lavastoviglie con ripiano

1 vasca, gocciolatoio a sinistra

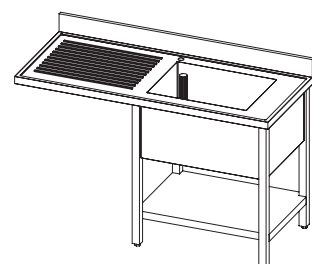

CODICE	PROF.	DIM. MOBILE	DIM. VASCA	
LSR7 1VGSX 11	70	110x70x85	40x50x30	
LSR7 1VGSX 12	70	120x70x85	50x50x30	
LSR7 1VGSX 13	70	130x70x85	50x50x30	
LSR7 1VGSX 14	70	140x70x85	60x50x30	

Lavello lavastoviglie con ripiano

2 vasche, gocciolatoio a destra

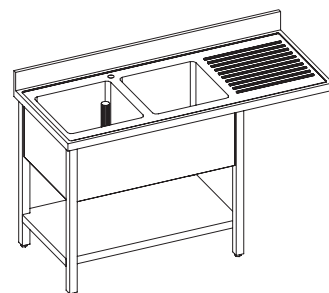

CODICE	PROF.	DIM. MOBILE	DIM. VASCA	
LSR7 2VGDX 15	70	150x70x85	40x50x30	
LSR7 2VGDX 16	70	160x70x85	40x50x30	
LSR7 2VGDX 17	70	170x70x85	40x50x30	
LSR7 2VGDX 18	70	180x70x85	50x50x30	
LSR7 2VGDX 19	70	190x70x85	50x50x30	
LSR7 2VGDX 20	70	200x70x85	60x50x30	
LSR7 2VGDX 21	70	210x70x85	60x50x30	
LSR7 2VGDX 22	70	220x70x85	60x50x30	

Lavello lavastoviglie con ripiano

2 vasche, gocciolatoio a sinistra

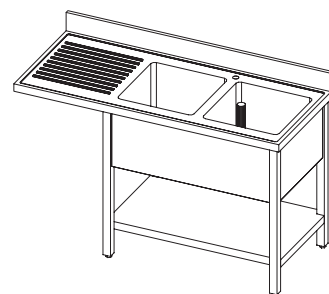

CODICE	PROF.	DIM. MOBILE	DIM. VASCA	
LSR7 2VGSX 15	70	150x70x85	40x50x30	
LSR7 2VGSX 16	70	160x70x85	40x50x30	
LSR7 2VGSX 17	70	170x70x85	40x50x30	
LSR7 2VGSX 18	70	180x70x85	50x50x30	
LSR7 2VGSX 19	70	190x70x85	50x50x30	
LSR7 2VGSX 20	70	200x70x85	60x50x30	
LSR7 2VGSX 21	70	210x70x85	60x50x30	
LSR7 2VGSX 21	70	220x70x85	60x50x30	

Lavello lavastoviglie con ante a battente

1 vasca, gocciolatoio a destra

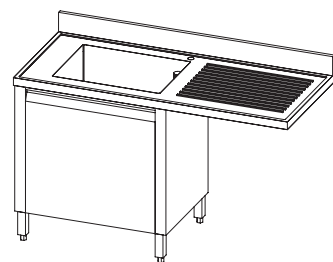

CODICE	PROF.	DIM. MOBILE	DIM. VASCA	
LSB7 1VGDX 11	70	110x70x85	40x50x30	
LSB7 1VGDX 12	70	120x70x85	50x50x30	
LSB7 1VGDX 13	70	130x70x85	50x50x30	
LSB7 1VGDX 14	70	140x70x85	50x50x30	

Lavello lavastoviglie con ante a battente

1 vasca, gocciolatoio a sinistra

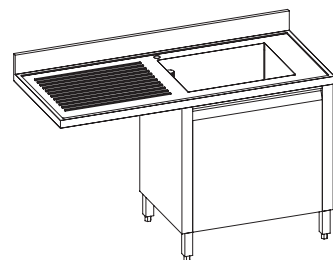

CODICE	PROF.	DIM. MOBILE	DIM. VASCA	
LSB7 1VGSX 11	70	110x70x85	40x50x30	
LSB7 1VGSX 12	70	120x70x85	50x50x30	
LSB7 1VGSX 13	70	130x70x85	50x50x30	
LSB7 1VGSX 14	70	140x70x85	50x50x30	

Lavello lavastoviglie con ante scorrevoli

2 vasche, gocciolatoio a destra

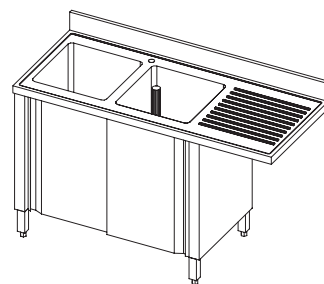

CODICE	PROF.	DIM. MOBILE	DIM. VASCA	
LSS7 2VGDX 15	70	150x70x85	40x50x30	
LSS7 2VGDX 16	70	160x70x85	40x50x30	
LSS7 2VGDX 17	70	170x70x85	50x50x30	
LSS7 2VGDX 18	70	180x70x85	50x50x30	
LSS7 2VGDX 19	70	190x70x85	50x50x30	
LSS7 2VGDX 20	70	200x70x85	60x50x30	
LSS7 2VGDX 21	70	210x70x85	60x50x30	
LSS7 2VGDX 22	70	210x70x85	60x50x30	

Lavello lavastoviglie con ante scorrevoli

2 vasche, gocciolatoio a sinistra

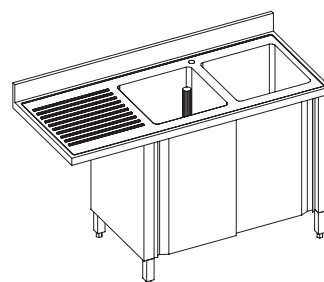

CODICE	PROF.	DIM. MOBILE	DIM. VASCA	
LSS7 2VGSX 15	70	150x70x85	40x50x30	
LSS7 2VGSX 16	70	160x70x85	40x50x30	
LSS7 2VGSX 17	70	170x70x85	50x50x30	
LSS7 2VGSX 18	70	180x70x85	50x50x30	
LSS7 2VGSX 19	70	190x70x85	50x50x30	
LSS7 2VGSX 20	70	200x70x85	60x50x30	
LSS7 2VGSX 21	70	210x70x85	60x50x30	
LSS7 2VGSX 22	70	210x70x85	60x50x30	

Lavapentole a giorno

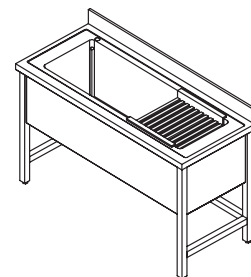

CODICE	PROF.	DIM. MOBILE	DIM. VASCA
LPG6 10	60	100x60x85	80x40x35
LPG6 12	60	120x60x85	95x50x35
LPG7 10	70	100x70x85	80x50x35
LPG7 12	70	120x70x85	110x50x35
LPG7 13	70	130x70x85	110x50x35
LPG7 14	70	140x70x85	120x50x35
LPG7 15	70	150x70x85	120x50x35
LPG7 16	70	160x70x85	140x50x35

Lavapentole con ripiano

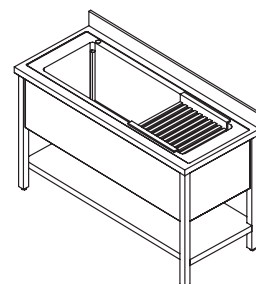

CODICE	PROF.	DIM. MOBILE	DIM. VASCA
LPR6 10	60	100x60x85	80x40x35
LPR6 12	60	120x60x85	95x50x35
LPR7 10	70	100x70x85	80x50x35
LPR7 12	70	120x70x85	110x50x35
LPR7 13	70	130x70x85	110x50x35
LPR7 14	70	140x70x85	120x50x35
LPR7 15	70	150x70x85	120x50x35
LPR7 16	70	160x70x85	140x50x35

Lavapentole armadiato con ante scorrevoli

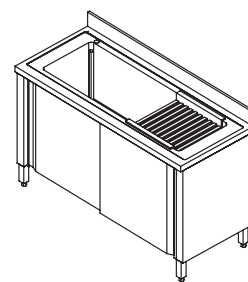

CODICE	PROF.	DIM. MOBILE	DIM. VASCA
LPS6 10	60	100x60x85	80x40x35
LPS6 12	60	120x60x85	95x50x35
LPS7 10	70	100x70x85	80x50x35
LPS7 12	70	120x70x85	110x50x35
LPS7 13	70	130x70x85	110x50x35
LPS7 14	70	140x70x85	120x50x35
LPS7 15	70	150x70x85	120x50x35
LPS7 16	70	160x70x85	140x50x35

Tavolo prelavaggio ingresso lavastoviglie

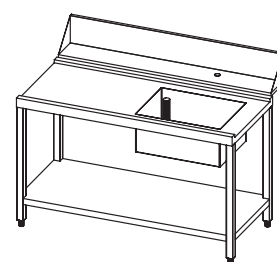

CODICE	PROF.	DIMENSIONI
TPL7 10	75	100x75x85
TPL7 11	75	110x75x85
TPL7 12	75	120x75x85
TPL7 13	75	130x75x85
TPL7 14	75	140x75x85
TPL7 15	75	150x75x85
TPL7 16	75	160x75x85
TPL7 17	75	170x75x85
TPL7 18	75	180x75x85
TPL7 19	75	190x75x85
TPL7 20	75	200x75x85

Tavolo uscita lavastoviglie

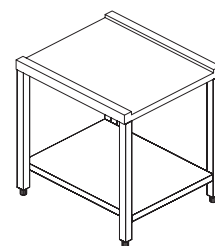

CODICE	PROF.	DIM. MOBILE
TUL6 07	60	70x60x85
TUL6 08	60	80x60x85
TUL6 09	60	90x60x85
TUL6 10	60	100x60x85
TUL6 11	60	110x60x85
TUL6 12	60	120x60x85
TUL6 13	60	130x60x85
TUL6 14	60	140x60x85

Tavolo preparazione carne/pesce

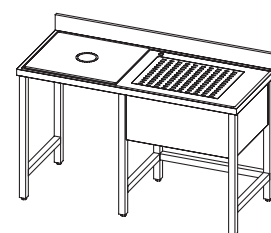

CODICE	PROF.	DIM. MOBILE
TPC7 12	70	120x70x85
TPC7 14	70	140x70x85
TPC7 16	70	160x70x85

Tavolo preparazione carne/pesce con ripiano

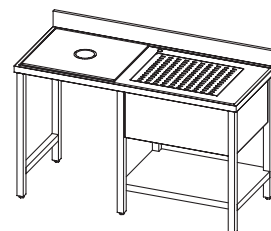

CODICE	PROF.	DIM. MOBILE
TPCR7 12	70	120x70x85
TPCR7 14	70	140x70x85
TPCR7 16	70	160x70x85

Tavolo preparazione verdure

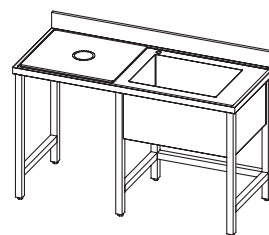

CODICE	PROF.	DIM. MOBILE
TPV7 12	70	120x70x85
TPV7 14	70	140x70x85
TPV7 16	70	160x70x85

Tavolo preparazione verdure con ripiano

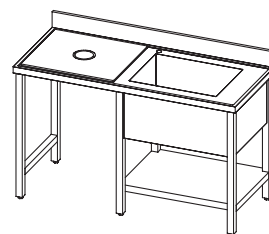

CODICE	PROF.	DIM. MOBILE
TPVR7 12	70	120x70x85
TPVR7 14	70	140x70x85
TPVR7 16	70	160x70x85

Tavolo sbarazzo e lavaggio stoviglie

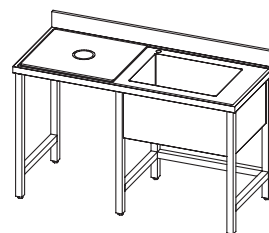

CODICE	PROF.	DIM. MOBILE
TSL7 14	70	140x70x85
TSL7 16	70	160x70x85
TSL7 18	70	180x70x85

Tavolo sbarazzo e lavaggio stoviglie con ripiano

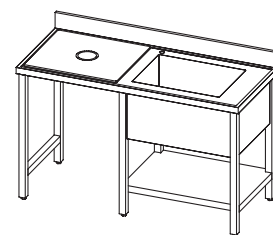

CODICE	PROF.	DIM. MOBILE	DIM. VASCA
TLSR7 14	70	140x70x85	
TLSR7 16	70	160x70x85	
TLSR7 18	70	180x70x85	

Falso fondo forato

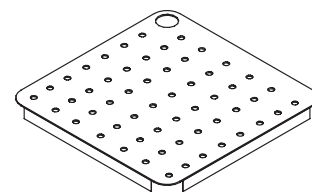

CODICE	DIMENSIONI
FFF	50x50

Griglia per lavapentole

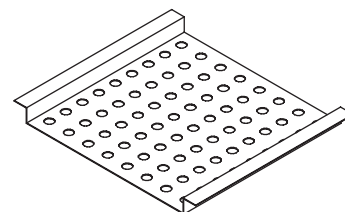

CODICE
GLP

RETROBAR



- Struttura in acciaio inox AISI 304 18/10 scotch brite anticorrosione e antitaglio;
- Accessori a richiesta: cassetti, cassettera, alzatine speciali, ruote etc.;
- Piano di lavoro in acciaio inox bordo 40 mm squadrato;
- Alzatina h 160 mm completamente saldata;
- Ripiano intermedio in acciaio inox con omega di rinforzo;
- Ante TAMBURRATE con chiusura a scorrevoli o a battente ;
- Guide cassetti di tipo telescopico;
- Per realizzazioni in acciaio inox AISI 304 LUCIDO +10%.

60

Tavolo armadiato a giorno

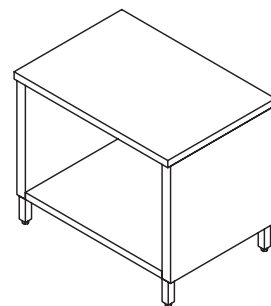

CODICE	DIMENSIONI cm	
RBG6 07	70x60x85	
RBG6 08	80x60x85	
RBG6 09	90x60x85	
RBG6 10	100x60x85	
RBG6 11	110x60x85	
RBG6 12	120x60x85	
RBG6 13	130x60x85	
RBG6 14	140x60x85	
RBG6 15	150x60x85	
RBG6 16	160x60x85	
RBG6 17	170x60x85	
RBG6 18	180x60x85	
RBG6 19	190x60x85	
RBG6 20	200x60x85	
RBG6 21	210x60x85	
RBG6 22	220x60x85	
RBG6 23	230x60x85	
RBG6 24	240x60x85	
RBG6 25	250x60x85	
RBG6 26	260x60x85	
RBG6 27	270x60x85	
RBG6 28	280x60x85	
RBG6 29	290x60x85	
RBG6 30	300x60x85	

70

Tavolo armadiato a giorno

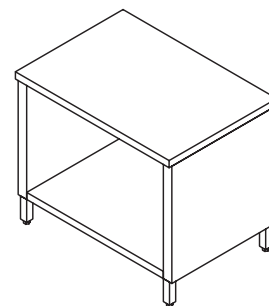

CODICE	DIMENSIONI cm	
RBG7 07	70x70x85	
RBG7 08	80x70x85	
RBG7 09	90x70x85	
RBG7 10	100x70x85	
RBG7 11	110x70x85	
RBG7 12	120x70x85	
RBG7 13	130x70x85	
RBG7 14	140x70x85	
RBG7 15	150x70x85	
RBG7 16	160x70x85	
RBG7 17	170x70x85	
RBG7 18	180x70x85	
RBG7 19	190x70x85	
RBG7 20	200x70x85	
RBG7 21	210x70x85	
RBG7 22	220x70x85	
RBG7 23	230x70x85	
RBG7 24	240x70x85	
RBG7 25	250x70x85	
RBG7 26	260x70x85	
RBG7 27	270x70x85	
RBG7 28	280x70x85	
RBG7 29	290x70x85	
RBG7 30	300x70x85	

60

Tavolo armadiato a giorno con alzatina

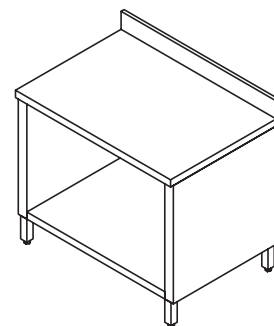

CODICE	DIMENSIONI cm	
RBGA6 07	70x60x85	
RBGA6 08	80x60x85	
RBGA6 09	90x60x85	
RBGA6 10	100x60x85	
RBGA6 11	110x60x85	
RBGA6 12	120x60x85	
RBGA6 13	130x60x85	
RBGA6 14	140x60x85	
RBGA6 15	150x60x85	
RBGA6 16	160x60x85	
RBGA6 17	170x60x85	
RBGA6 18	180x60x85	
RBGA6 19	190x60x85	
RBGA6 20	200x60x85	
RBGA6 21	210x60x85	
RBGA6 22	220x60x85	
RBGA6 23	230x60x85	
RBGA6 24	240x60x85	
RBGA6 25	250x60x85	
RBGA6 26	260x60x85	
RBGA6 27	270x60x85	
RBGA6 28	280x60x85	
RBGA6 29	290x60x85	
RBGA6 30	300x60x85	

70

Tavolo armadiato a giorno con alzatina

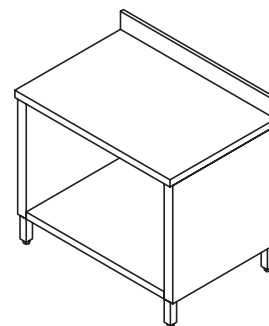

CODICE	DIMENSIONI cm	
RBGA7 07	70x70x85	
RBGA7 08	80x70x85	
RBGA7 09	90x70x85	
RBGA7 10	100x70x85	
RBGA7 11	110x70x85	
RBGA7 12	120x70x85	
RBGA7 13	130x70x85	
RBGA7 14	140x70x85	
RBGA7 15	150x70x85	
RBGA7 16	160x70x85	
RBGA7 17	170x70x85	
RBGA7 18	180x70x85	
RBGA7 19	190x70x85	
RBGA7 20	200x70x85	
RBGA7 21	210x70x85	
RBGA7 22	220x70x85	
RBGA7 23	230x70x85	
RBGA7 24	240x70x85	
RBGA7 25	250x70x85	
RBGA7 26	260x70x85	
RBGA7 27	270x70x85	
RBGA7 28	280x70x85	
RBGA7 29	290x70x85	
RBGA7 30	300x70x85	

60

Tavolo armadiato a giorno con ripiano regolabile in 3 posizioni

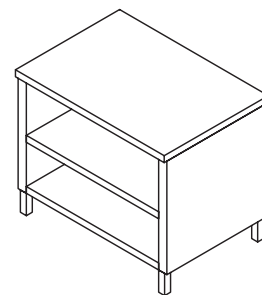

CODICE	DIMENSIONI cm	
RBGR6 07	70x60x85	
RBGR6 08	80x60x85	
RBGR6 09	90x60x85	
RBGR6 10	100x60x85	
RBGR6 11	110x60x85	
RBGR6 12	120x60x85	
RBGR6 13	130x60x85	
RBGR6 14	140x60x85	
RBGR6 15	150x60x85	
RBGR6 16	160x60x85	
RBGR6 17	170x60x85	
RBGR6 18	180x60x85	
RBGR6 19	190x60x85	
RBGR6 20	200x60x85	
RBGR6 21	210x60x85	
RBGR6 22	220x60x85	
RBGR6 23	230x60x85	
RBGR6 24	240x60x85	
RBGR6 25	250x60x85	
RBGR6 26	260x60x85	
RBGR6 27	270x60x85	
RBGR6 28	280x60x85	
RBGR6 29	290x60x85	
RBGR6 30	300x60x85	

70

Tavolo armadiato a giorno con ripiano

regolabile in 3 posizioni

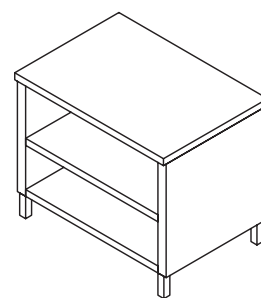

CODICE	DIMENSIONI cm	
RBGR7 07	70x70x85	
RBGR7 08	80x70x85	
RBGR7 09	90x70x85	
RBGR7 10	100x70x85	
RBGR7 11	110x70x85	
RBGR7 12	120x70x85	
RBGR7 13	130x70x85	
RBGR7 14	140x70x85	
RBGR7 15	150x70x85	
RBGR7 16	160x70x85	
RBGR7 17	170x70x85	
RBGR7 18	180x70x85	
RBGR7 19	190x70x85	
RBGR7 20	200x70x85	
RBGR7 21	210x70x85	
RBGR7 22	220x70x85	
RBGR7 23	230x70x85	
RBGR7 24	240x70x85	
RBGR7 25	250x70x85	
RBGR7 26	260x70x85	
RBGR7 27	270x70x85	
RBGR7 28	280x70x85	
RBGR7 29	290x70x85	
RBGR7 30	300x70x85	

60

Tavolo armadiato a giorno con alzatina e ripiano

regolabile in 3 posizioni

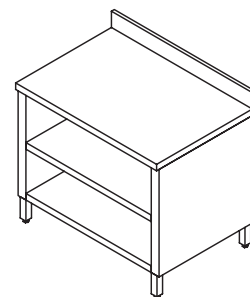

CODICE	DIMENSIONI cm	
RBGRA6 07	70x60x85	
RBGRA6 08	80x60x85	
RBGRA6 09	90x60x85	
RBGRA6 10	100x60x85	
RBGRA6 11	110x60x85	
RBGRA6 12	120x60x85	
RBGRA6 13	130x60x85	
RBGRA6 14	140x60x85	
RBGRA6 15	150x60x85	
RBGRA6 16	160x60x85	
RBGRA6 17	170x60x85	
RBGRA6 18	180x60x85	
RBGRA6 19	190x60x85	
RBGRA6 20	200x60x85	
RBGRA6 21	210x60x85	
RBGRA6 22	220x60x85	
RBGRA6 23	230x60x85	
RBGRA6 24	240x60x85	
RBGRA6 25	250x60x85	
RBGRA6 26	260x60x85	
RBGRA6 27	270x60x85	
RBGRA6 28	280x60x85	
RBGRA6 29	290x60x85	
RBGRA6 30	300x60x85	

70

Tavolo armadiato a giorno con alzatina e ripiano

regolabile in 3 posizioni

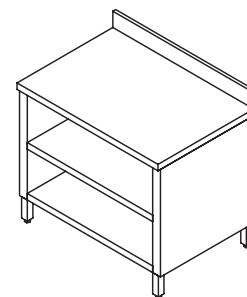

CODICE	DIMENSIONI cm	
RBGRA7 07	70x70x85	
RBGRA7 08	80x70x85	
RBGRA7 09	90x70x85	
RBGRA7 10	100x70x85	
RBGRA7 11	110x70x85	
RBGRA7 12	120x70x85	
RBGRA7 13	130x70x85	
RBGRA7 14	140x70x85	
RBGRA7 15	150x70x85	
RBGRA7 16	160x70x85	
RBGRA7 17	170x70x85	
RBGRA7 18	180x70x85	
RBGRA7 19	190x70x85	
RBGRA7 20	200x70x85	
RBGRA7 21	210x70x85	
RBGRA7 22	220x70x85	
RBGRA7 23	230x70x85	
RBGRA7 24	240x70x85	
RBGRA7 25	250x70x85	
RBGRA7 26	260x70x85	
RBGRA7 27	270x70x85	
RBGRA7 28	280x70x85	
RBGRA7 29	290x70x85	
RBGRA7 30	300x70x85	

60

Tavolo armadiato con ante scorrevoli

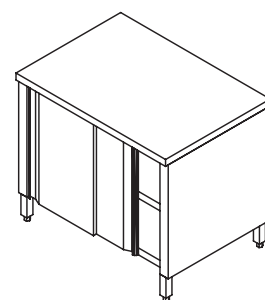

CODICE	DIMENSIONI cm	
RBS6 10	100x60x85	
RBS6 11	110x60x85	
RBS6 12	120x60x85	
RBS6 13	130x60x85	
RBS6 14	140x60x85	
RBS6 15	150x60x85	
RBS6 16	160x60x85	
RBS6 17	170x60x85	
RBS6 18	180x60x85	
RBS6 19	190x60x85	
RBS6 20	200x60x85	
RBS6 21	210x60x85	
RBS6 22	220x60x85	
RBS6 23	230x60x85	
RBS6 24	240x60x85	
RBS6 25	250x60x85	
RBS6 26	260x60x85	
RBS6 27	270x60x85	
RBS6 28	280x60x85	
RBS6 29	290x60x85	
RBS6 30	300x60x85	

70

Tavolo armadiato con ante scorrevoli

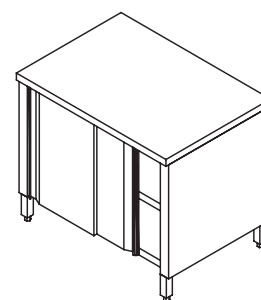

CODICE	DIMENSIONI cm	
RBS7 10	100x70x85	
RBS7 11	110x70x85	
RBS7 12	120x70x85	
RBS7 13	130x70x85	
RBS7 14	140x70x85	
RBS7 15	150x70x85	
RBS7 16	160x70x85	
RBS7 17	170x70x85	
RBS7 18	180x70x85	
RBS7 19	190x70x85	
RBS7 20	200x70x85	
RBS7 21	210x70x85	
RBS7 22	220x70x85	
RBS7 23	230x70x85	
RBS7 24	240x70x85	
RBS7 25	250x70x85	
RBS7 26	260x70x85	
RBS7 27	270x70x85	
RBS7 28	280x70x85	
RBS7 29	290x70x85	
RBS7 30	300x70x85	

60

Tavolo armadiato con ante scorrevoli e alzatina

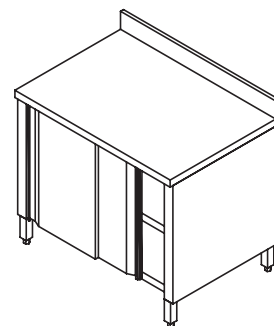

CODICE	DIMENSIONI cm	
RBSA6 10	100x60x85	
RBSA6 11	110x60x85	
RBSA6 12	120x60x85	
RBSA6 13	130x60x85	
RBSA6 14	140x60x85	
RBSA6 15	150x60x85	
RBSA6 16	160x60x85	
RBSA6 17	170x60x85	
RBSA6 18	180x60x85	
RBSA6 19	190x60x85	
RBSA6 20	200x60x85	
RBSA6 21	210x60x85	
RBSA6 22	220x60x85	
RBSA6 23	230x60x85	
RBSA6 24	240x60x85	
RBSA6 25	250x60x85	
RBSA6 26	260x60x85	
RBSA6 27	270x60x85	
RBSA6 28	280x60x85	
RBSA6 29	290x60x85	
RBSA6 30	300x60x85	

70

Tavolo armadiato con ante scorrevoli e alzatina

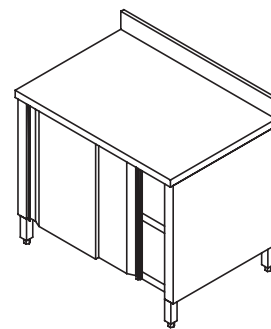

CODICE	DIMENSIONI cm	
RBSA7 10	100x70x85	
RBSA7 11	110x70x85	
RBSA7 12	120x70x85	
RBSA7 13	130x70x85	
RBSA7 14	140x70x85	
RBSA7 15	150x70x85	
RBSA7 16	160x70x85	
RBSA7 17	170x70x85	
RBSA7 18	180x70x85	
RBSA7 19	190x70x85	
RBSA7 20	200x70x85	
RBSA7 21	210x70x85	
RBSA7 22	220x70x85	
RBSA7 23	230x70x85	
RBSA7 24	240x70x85	
RBSA7 25	250x70x85	
RBSA7 26	260x70x85	
RBSA7 27	270x70x85	
RBSA7 28	280x70x85	
RBSA7 29	290x70x85	
RBSA7 30	300x70x85	

60

Tavolo armadiato con ante scorrevoli e 3 cassetti

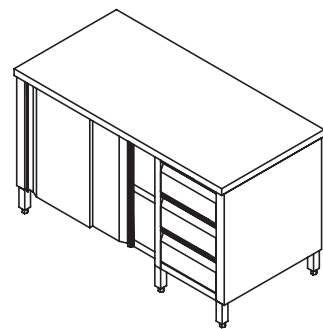

CODICE	DIMENSIONI cm	
RBSC6 14	140x60x85	
RBSC6 15	150x60x85	
RBSC6 16	160x60x85	
RBSC6 17	170x60x85	
RBSC6 18	180x60x85	
RBSC6 19	190x60x85	
RBSC6 20	200x60x85	
RBSC6 21	210x60x85	
RBSC6 22	220x60x85	
RBSC6 23	230x60x85	
RBSC6 24	240x60x85	

70

Tavolo armadiato con ante scorrevoli e 3 cassetti

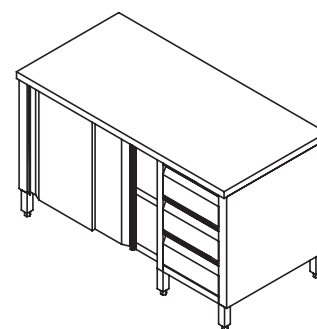

CODICE	DIMENSIONI cm	
RBSC7 14	140x70x85	
RBSC7 15	150x70x85	
RBSC7 16	160x70x85	
RBSC7 17	170x70x85	
RBSC7 18	180x70x85	
RBSC7 19	190x70x85	
RBSC7 20	200x70x85	
RBSC7 21	210x70x85	
RBSC7 22	220x70x85	
RBSC7 23	230x70x85	
RBSC7 24	240x70x85	

60

Tavolo armadiato con ante scorrevoli, 3 cassetti e alzatina

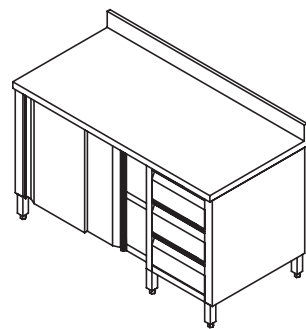

CODICE	DIMENSIONI cm	
RBSCA6 14	140x60x85	
RBSCA6 15	150x60x85	
RBSCA6 16	160x60x85	
RBSCA6 17	170x60x85	
RBSCA6 18	180x60x85	
RBSCA6 19	190x60x85	
RBSCA6 20	200x60x85	
RBSCA6 21	210x60x85	
RBSCA6 22	220x60x85	
RBSCA6 23	230x60x85	
RBSCA6 24	240x60x85	

70

Tavolo armadiato con ante scorrevoli, 3 cassetti e alzatina

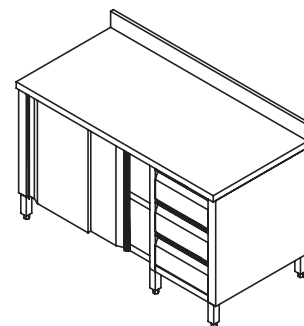

CODICE	DIMENSIONI cm	
RBSCA7 14	140x70x85	
RBSCA7 15	150x70x85	
RBSCA7 16	160x70x85	
RBSCA7 17	170x70x85	
RBSCA7 18	180x70x85	
RBSCA7 19	190x70x85	
RBSCA7 20	200x70x85	
RBSCA7 21	210x70x85	
RBSCA7 22	220x70x85	
RBSCA7 23	230x70x85	
RBSCA7 24	240x70x85	

60

Tavolo armadiato con ante a battente

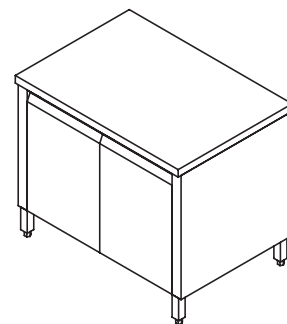

CODICE	DIMENSIONI cm	
RBB6 07	70x60x85	
RBB6 08	80x60x85	
RBB6 09	90x60x85	
RBB6 10	100x60x85	
RBB6 11	110x60x85	
RBB6 12	120x60x85	

Tavolo armadiato con ante a battente e alzatina

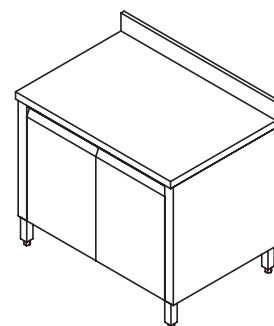

CODICE	DIMENSIONI cm	
RBBA6 07	70x60x85	
RBBA6 08	80x60x85	
RBBA6 09	90x60x85	
RBBA6 10	100x60x85	
RBBA6 11	110x60x85	
RBBA6 12	120x60x85	

70

Tavolo armadiato con ante a battente

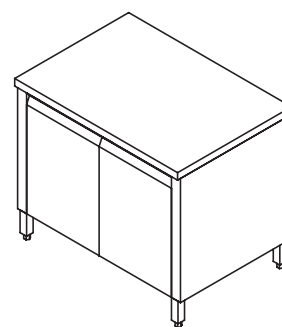

CODICE	DIMENSIONI cm	
RBB7 07	70x70x85	
RBB7 08	80x70x85	
RBB7 09	90x70x85	
RBB7 10	100x70x85	
RBB7 11	110x70x85	
RBB7 12	120x70x85	

Tavolo armadiato con ante a battente e alzatina

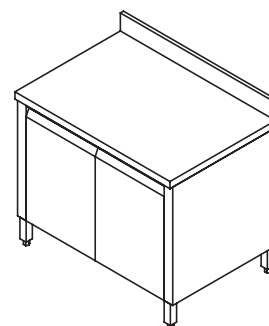

CODICE	DIMENSIONI cm	
RBBA7 07	70x70x85	
RBBA7 08	80x70x85	
RBBA7 09	90x70x85	
RBBA7 10	100x70x85	
RBBA7 11	110x70x85	
RBBA7 12	120x70x85	

60

Tavolo armadiato con ante a battente e 3 cassetti

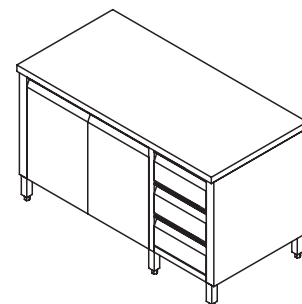

CODICE	DIMENSIONI cm	
RBBC6 10	100x60x85	
RBBC6 11	110x60x85	
RBBC6 12	120x60x85	
RBBC6 13	130x60x85	
RBBC6 14	140x60x85	

Tavolo armadiato con ante a battente 3 cassetti e alzatina

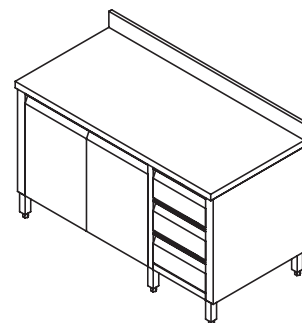

CODICE	DIMENSIONI cm	
RBBAC6 10	100x60x85	
RBBAC6 11	110x60x85	
RBBAC6 12	120x60x85	
RBBCA6 13	130x60x85	
RBBCA6 14	140x60x85	

70

Tavolo armadiato con ante a battente e 3 cassetti

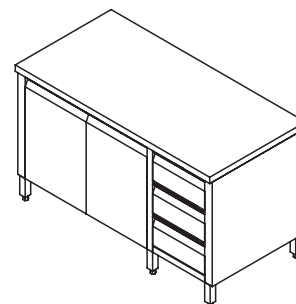

CODICE	DIMENSIONI cm	
RBBC7 10	100x70x85	
RBBC7 11	110x70x85	
RBBC7 12	120x70x85	
RBBC7 13	130x70x85	
RBBC7 14	140x70x85	

Tavolo armadiato con ante a battente 3 cassetti e alzatina

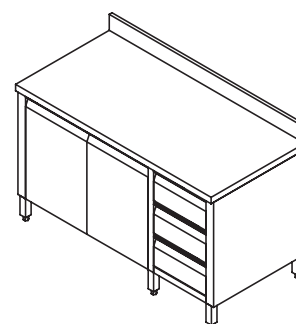

CODICE	DIMENSIONI cm	
RBBCA7 10	100x70x85	
RBBCA7 11	110x70x85	
RBBCA7 12	120x70x85	
RBBCA7 13	130x70x85	
RBBCA7 14	140x70x85	

60

Retro bar con 1 batticaffè e 1 cassetto neutro

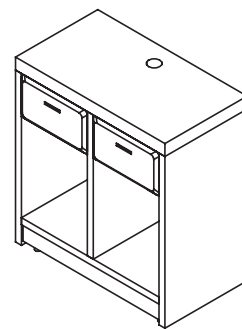

CODICE	DIMENSIONI cm	
MCBC6 10	100x60x85	
MCBC6 12	125x60x85	

Retro bar con 1 batticaffè e 2 cassetti neutri

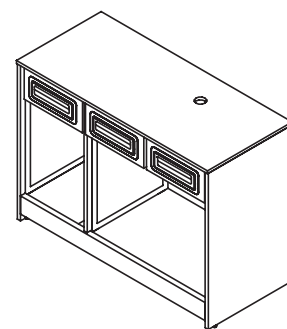

CODICE	DIMENSIONI cm	
MCB2C6 15	150x60x85	

Retro bar con 1 tramoggia batticaffè e 1 cassetto neutro

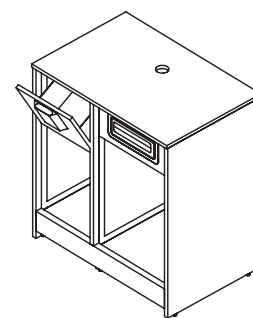

CODICE	DIMENSIONI cm	
MCTBC6 10	100x60x85	
MCTBC6 12	125x60x85	

70

Retro bar con 1 batticaffè e 1 cassetto neutro

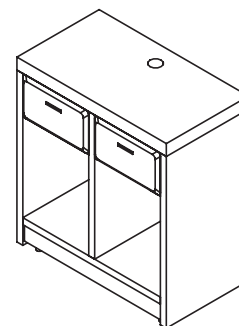

CODICE	DIMENSIONI cm	
MCBC7 10	100x70x85	
MCBC7 12	125x70x85	

Retro bar con 1 batticaffè e 2 cassetti neutri

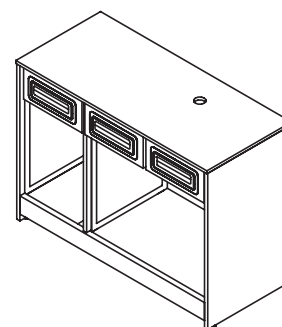

CODICE	DIMENSIONI cm	
MCB2C7 15	150x70x85	

Retro bar con 1 tramoggia batticaffè e 1 cassetto neutro

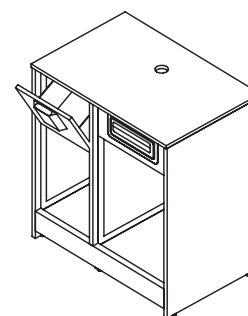

CODICE	DIMENSIONI cm	
MCTBC7 10	100x70x85	
MCTBC7 12	125x70x85	

60

Retro bar con 1 tramoggia batticaffè e 2 cassetti neutri

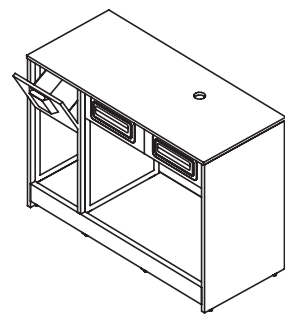

CODICE	DIMENSIONI cm	
MCTB2C6 15	150x60x85	

Retro base con 1 batticaffè e 1 cassetto neutro

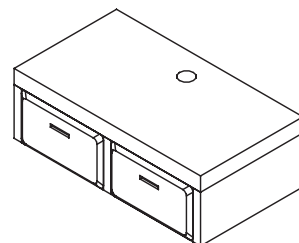

CODICE	DIMENSIONI cm	
MCBRBC6 10	100x60x85	
MCBRBC6 12	125x60x85	

Retro base con 1 batticaffè e 2 cassetti neutri

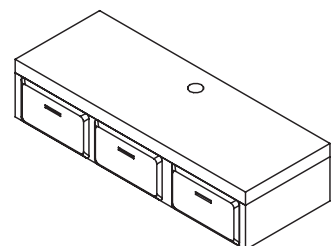

CODICE	DIMENSIONI cm	
MCBRB2C6 15	150x60x85	

70

Retro bar con 1 tramoggia batticaffè e 2 cassette neutri

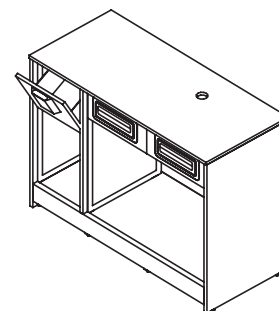

CODICE	DIMENSIONI cm	
MCTB2C7 15	150x70x85	

Retro base con 1 batticaffè e 1 cassetto neutro

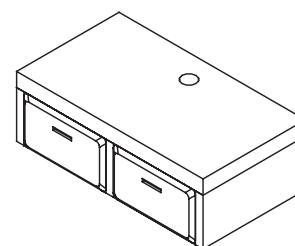

CODICE	DIMENSIONI cm	
MCBRBC7 10	100x70x85	
MCBRBC7 12	125x70x85	

Retro base con 1 batticaffè e 2 cassette neutri

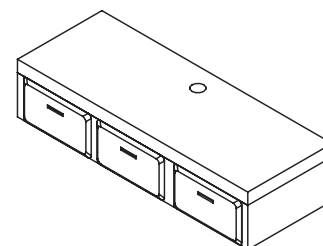

CODICE	DIMENSIONI cm	
MCBRB2C7 15	150x70x85	

LINEA CARNI



- Struttura in acciaio inox AISI 304 18/10 scotch brite anticorrosione e antitaglio;

**Carrello inox per salumifici con n. 2 barre dentate
per appoggio correntini porta insaccati
con alloggiamento inferiore per i correntini non utilizzati
(portata max 400 kg)**

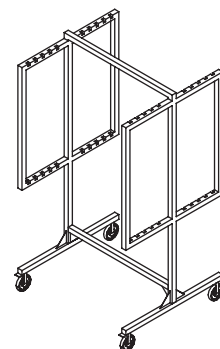

CODICE	DIMENSIONI cm
CC2	106x95x180

**Carrello inox per salumifici con n. 3 barre dentate
per appoggio correntini porta insaccati
con alloggiamento inferiore per i correntini non utilizzati
(portata max 400 kg)**

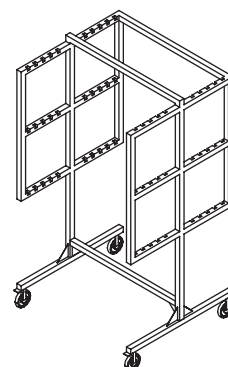

CODICE	DIMENSIONI cm
CC3	106x95x195

Correntino per carrelli

CODICE	DIMENSIONI cm	
MCBRB2C6 10	99xø2	

Spalliera prosciutti singola con n. 5 barre di aggancio dotate di perni alternati movimentabile con transpallet appoggio a terra in materiale plastico

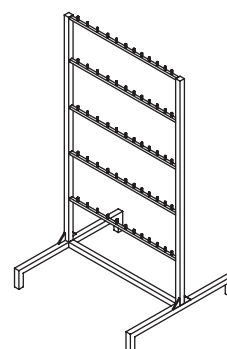

CODICE	DIMENSIONI cm	
SP5	106x95x180	

LINEA CAPPE



- Struttura in acciaio inox AISI 304 18/10 scotch brite;
- Assemblata tramite saldatura a TIG completamente ribordata anche nelle parti interne;
- Rubinetto di scarico, canalina perimetrale raccogli condensa;
- Filtri antigrasso a labirinto

**CAPPE
SENZA
MOTORE**

Cappa Snack a parete

Senza motore



Costruzione in acciaio inox AISI 304 .

Accessoriate di filtri in AISI 304 a labirinto facilmente estraibili per il lavaggio periodico.

I filtri a labirinto assicurano una filtrazione costante (senza intasamenti) e sicura (protezione contro il rischio di incendio).

Canalina posteriore con foro di scarico che convoglia i grassi in una bacinella ai AISI 304.

Tutte le lamiere accessibili dalla mano dell'operatore hanno la doppia piega per evitare ferite.

Predisposte per l'illuminazione.

Dotate di pannelli ciechi in AISI 304 per un giusto bilanciamento dell'aspirazione.

Le dimensioni dei fori di espulsione dell'aria sono dimensionate in modo tale da ridurre al minimo le perdite di carico.

Tutte le cappe sono dotate di bacinella di scarico condensa in AISI 304.

In dotazione golfari, tasselli metallici M8 e staffe di sostegno per la sospensione a soffitto.

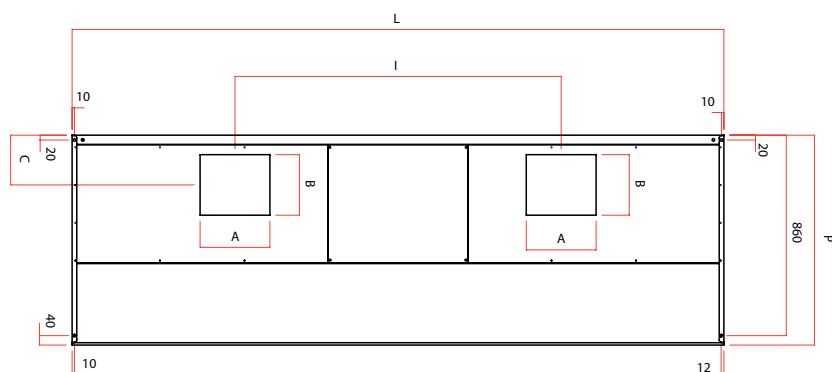
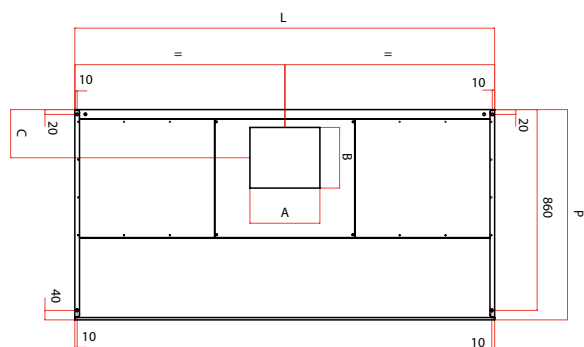
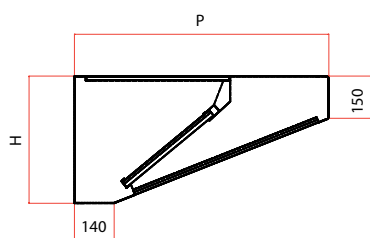

Dimensioni in mm.

CODICE	DIMENSIONI cm	AxB cm	C cm	FILTRI n°	VOLUME MC/H*	
CSP 9 10	100x90x50	23x20	23	2	1.100	
CSP 9 12	120x90x50	23x20	23	2	1.400	
CSP 9 14	140x90x50	23x20	23	2	1.600	
CSP 9 16	160x90x50	30x26	21	3	1.800	
CSP 9 18	180x90x50	30x26	21	3	2.000	
CSP 9 20	200x90x50	30x26	21	4	2.250	
CSP 9 22	220x90x50	30x26	21	4	2.500	
CSP 9 24	240x90x50	30x26	21	4	2.700	
CSP 9 26	260x90x50	30x26x2	21	4	2.950	
CSP 9 28	280x90x50	30x26x2	21	5	3.200	
CSP 9 30	300x90x50	30x26x2	21	5	3.400	
CSP 9 32	320x90x50	30x26x2	21	5	3.650	
CSP 9 34	340x90x50	30x26x2	21	6	3.850	
CSP 9 36	360x90x50	30x26x2	21	6	4.050	
CSP 9 38	380x90x50	30x26x2	21	6	4.300	
CSP 9 40	400x90x50	30x26x2	21	7	4.500	
CSP 11 10	100x110x50	23x20	23	2	1.400	
CSP 11 12	120x110x50	30x26	21	2	1.700	
CSP 11 14	140x110x50	30x26	21	2	1.950	
CSP 11 16	160x110x50	30x26	21	3	2.200	
CSP 11 18	180x110x50	30x26	21	3	2.500	
CSP 11 20	200x110x50	30x26	21	4	2.800	
CSP 11 22	220x110x50	30x26	21	4	3.100	
CSP 11 24	240x110x50	30x26	21	4	3.400	
CSP 11 26	260x110x50	30x26x2	21	4	3.600	
CSP 11 28	280x110x50	30x26x2	21	5	3.900	
CSP 11 30	300x110x50	30x26x2	21	5	4.200	
CSP 11 32	320x110x50	30x26x2	21	5	4.500	
CSP 11 34	340x110x50	30x26x2	21	6	4.700	
CSP 11 36	360x110x50	30x26x2	21	6	5.000	
CSP 11 38	380x110x50	30x26x2	21	6	5.300	
CSP 11 40	400x110x50	30x26x2	21	7	5.500	

Cappa Snack centrale

Senza motore

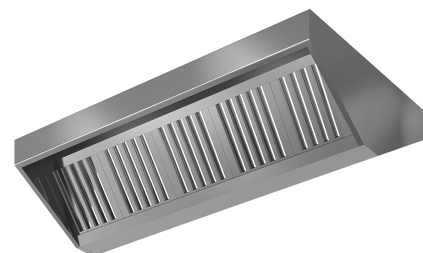

Costruzione in acciaio inox AISI 304 .

Accessoriate di filtri in AISI 304 a labirinto facilmente estraibili per il lavaggio periodico.

I filtri a labirinto assicurano una filtrazione costante (senza intasamenti) e sicura (protezione contro il rischio di incendio).

Canalina centrale con foro di scarico che convoglia i grassi in una bacinella ai AISI 304.

Tutte le lamiere accessibili dalla mano dell'operatore hanno la doppia piega per evitare ferite.

Predisposte per l'illuminazione.

Dotate di pannelli ciechi in AISI 304 per un giusto bilanciamento dell'aspirazione.

Le dimensioni dei fori di espulsione dell'aria sono dimensionate in modo tale da ridurre al minimo le perdite di carico.

Tutte le cappe sono dotate di bacinella di scarico condensa in AISI 304.

In dotazione golfari, tasselli metallici M8 e staffe di sostegno per la sospensione a soffitto.

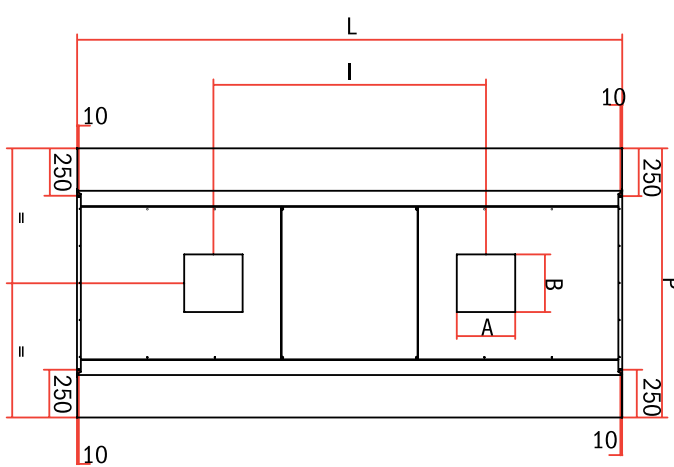
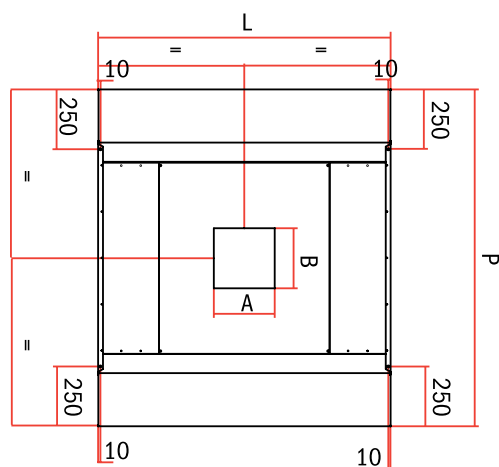
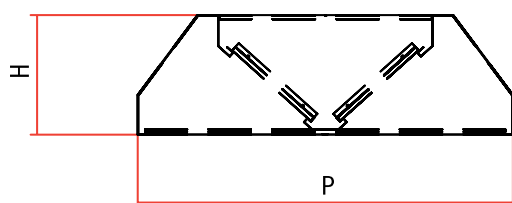

Dimensioni in mm..

CODICE	DIMENSIONI cm	AxB cm	FILTRI n°	VOLUME MC/H*	
CSC 14 12	120x140x50	25x25	4	2.100	
CSC 14 14	140x140x50	25x25	4	2.500	
CSC 14 16	160x140x50	30x30	6	2.800	
CSC 14 18	180x140x50	30x30	6	3.200	
CSC 14 20	200x140x50	30x30	8	3.500	
CSC 14 22	220x140x50	40x30	8	3.950	
CSC 14 24	240x140x50	40x30	8	4.200	
CSC 14 26	260x140x50	30x30x2	8	4.600	
CSC 14 28	280x140x50	30x30x2	10	4.900	
CSC 14 30	300x140x50	30x30x2	10	5.300	
CSC 14 32	320x140x50	30x30x2	10	5.600	
CSC 14 34	340x140x50	30x30x2	12	6.000	
CSC 14 36	360x140x50	30x30x2	12	6.400	
CSC 14 38	380x140x50	30x30x2	12	6.700	
CSC 14 40	400x140x50	30x30x2	12	7.000	
CSC 20 12	120x200x50	30x30	4	2.750	
CSC 20 14	140x200x50	30x30	6	3.200	
CSC 20 16	160x200x50	30x30	6	3.650	
CSC 20 18	180x200x50	40x30	6	4.050	
CSC 20 20	200x200x50	40x30	8	4.550	
CSC 20 22	220x200x50	40x30	8	5.000	
CSC 20 24	240x200x50	30x30x2	8	5.450	
CSC 20 26	260x200x50	30x30x2	8	5.900	
CSC 20 28	280x200x50	30x30x2	10	6.350	
CSC 20 30	300x200x50	40x30x2	10	6.800	
CSC 20 32	320x200x50	40x30x2	10	7.250	
CSC 20 34	340x200x50	40x30x2	12	7.700	
CSC 20 36	360x200x50	40x30x2	12	8.200	
CSC 20 38	380x200x50	40x30x2	12	8.600	
CSC 20 40	400x200x50	40x30x2	12	9.000	

Cappa a parete

Senza motore



Costruzione in acciaio inox AISI 304 .

Accessoriate di filtri in AISI 304 a labirinto facilmente estraibili per il lavaggio periodico.

I filtri a labirinto assicurano una filtrazione costante (senza intasamenti) e sicura (protezione contro il rischio di incendio).

Canalina perimetrale con foro di scarico che convoglia i grassi in una bacinella ai AISI 304.

Tutte le lamiere accessibili dalla mano dell'operatore hanno la doppia piega per evitare ferite.

Predisposte per l'illuminazione.

Dotate di pannelli ciechi in AISI 304 per un giusto bilanciamento dell'aspirazione.

Le dimensioni dei fori di espulsione dell'aria sono dimensionate in modo tale da ridurre al minimo le perdite di carico.

Tutte le cappe sono dotate di bacinella di scarico condensa in AISI 304.

In dotazione golfari, tasselli metallici M8 e staffe di sostegno per la sospensione a soffitto.

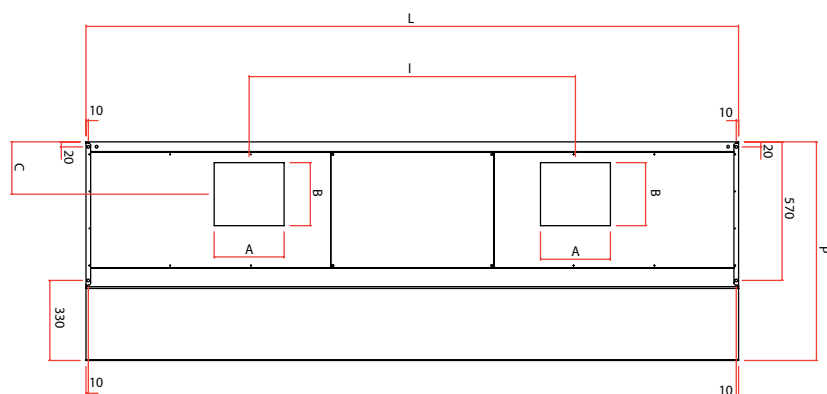
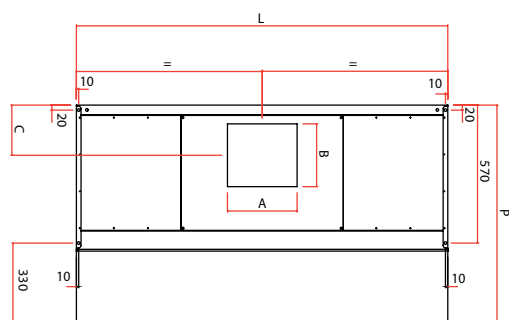
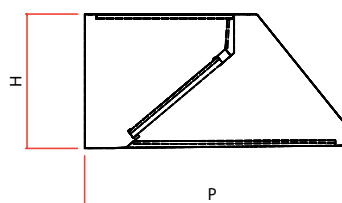

Dimensioni in mm.

CODICE	DIMENSIONI cm	AxB cm	C cm	FILTRI n°	VOLUME MC/H*	
CP 9 10	100x90x50	23x20	23	2	1.100	
CP 9 12	120x90x50	23x20	23	2	1.400	
CP 9 14	140x90x50	23x20	23	2	1.600	
CP 9 16	160x90x50	30x26	21	3	1.800	
CP 9 18	180x90x50	30x26	21	3	2.000	
CP 9 20	200x90x50	30x26	21	4	2.250	
CP 9 22	220x90x50	30x26	21	4	2.500	
CP 9 24	240x90x50	30x26	21	4	2.700	
CP 9 26	260x90x50	30x26x2	21	4	2.950	
CP 9 28	280x90x50	30x26x2	21	5	3.200	
CP 9 30	300x90x50	30x26x2	21	5	3.400	
CP 9 32	320x90x50	30x26x2	21	5	3.650	
CP 9 34	340x90x50	30x26x2	21	6	3.850	
CP 9 36	360x90x50	30x26x2	21	6	4.050	
CP 9 38	380x90x50	30x26x2	21	6	4.300	
CP 9 40	400x90x50	30x26x2	21	6	4.500	
CP 11 10	100x110x50	23x20	23	2	1.400	
CP 11 12	120x110x50	30x26	21	2	1.700	
CP 11 14	140x110x50	30x26	21	2	1.950	
CP 11 16	160x110x50	30x26	21	3	2.200	
CP 11 18	180x110x50	30x26	21	3	2.500	
CP 11 20	200x110x50	30x26	21	4	2.800	
CP 11 22	220x110x50	30x26	21	4	3.100	
CP 11 24	240x110x50	30x26x2	21	4	3.400	
CP 11 26	260x110x50	30x26x2	21	4	3.600	
CP 11 28	280x110x50	30x26x2	21	5	3.900	
CP 11 30	300x110x50	30x26x2	21	5	4.200	
CP 11 32	320x110x50	30x26x2	21	5	4.500	
CP 11 34	340x110x50	30x26x2	21	6	4.700	
CP 11 36	360x110x50	30x26x2	21	6	5.000	
CP 11 38	380x110x50	30x26x2	21	6	5.300	
CP 11 40	400x110x50	30x26x2	21	6	5.600	
CP 14 12	120x140x50	25x25	30	2	2.100	
CP 14 14	140x140x50	25x25	30	2	2.500	
CP 14 16	160x140x50	30x30	30	3	2.800	
CP 14 18	180x140x50	30x30	30	3	3.200	
CP 14 20	200x140x50	30x30	30	4	3.500	
CP 14 22	220x140x50	30x30	30	4	3.900	
CP 14 24	240x140x50	30x30x2	30	4	4.200	
CP 14 26	260x140x50	40x30x2	30	4	4.600	
CP 14 28	280x140x50	40x30x2	30	5	4.900	
CP 14 30	300x140x50	40x30x2	30	5	5.300	
CP 14 32	320x140x50	40x30x2	30	5	5.600	
CP 14 34	340x140x50	40x40x2	30	6	6.000	
CP 14 36	360x140x50	40x40x2	30	6	6.400	
CP 14 38	380x140x50	40x40x2	30	6	6.700	
CP 14 40	400x140x50	40x40x2	30	6	7.000	

Cappa centrale

Senza motore



Costruzione in acciaio inox AISI 304 .

Accessoriate di filtri in AISI 304 a labirinto facilmente estraibili per il lavaggio periodico.

I filtri a labirinto assicurano una filtrazione costante (senza intasamenti) e sicura (protezione contro il rischio di incendio).

Canalina perimetrale con foro di scarico che convoglia i grassi in una bacinella ai AISI 304.

Tutte le lamiere accessibili dalla mano dell'operatore hanno la doppia piega per evitare ferite.

Predisposte per l'illuminazione.

Dotate di pannelli ciechi in AISI 304 per un giusto bilanciamento dell'aspirazione.

Le dimensioni dei fori di espulsione dell'aria sono dimensionate in modo tale da ridurre al minimo le perdite di carico.

Tutte le cappe sono dotate di bacinella di scarico condensa in AISI 304.

In dotazione golfari, tasselli metallici M8 e staffe di sostegno per la sospensione a soffitto.

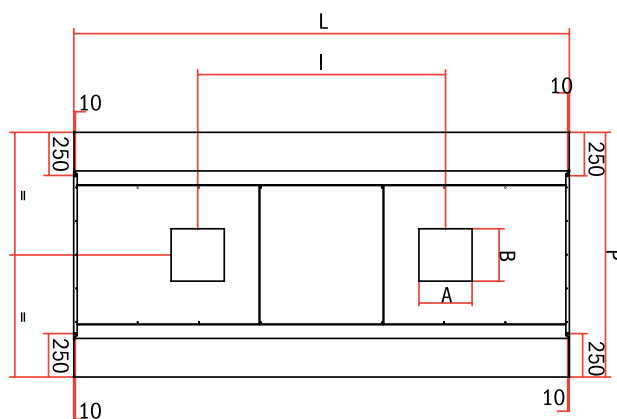
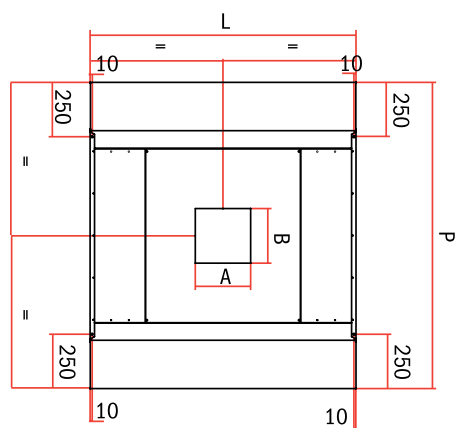
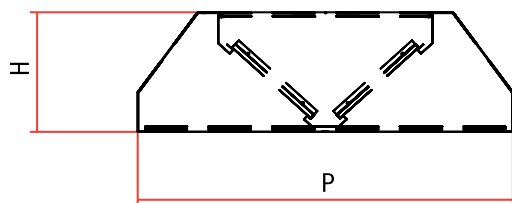

Dimensioni in mm.

CODICE	DIMENSIONI cm	AxB cm	FILTRI n°	VOLUME MC/H*	
CC 14 12	120x140x50	25x25	4	2.100	
CC 14 14	140x140x50	25x25	4	2.500	
CC 14 16	160x140x50	30x30	6	2.800	
CC 14 18	180x140x50	30x30	6	3.200	
CC 14 20	200x140x50	30x30	8	3.500	
CC 14 22	220x140x50	40x30	8	3.950	
CC 14 24	240x140x50	40x30	8	4.200	
CC 14 26	260x140x50	30x30x2	8	4.600	
CC 14 28	280x140x50	30x30x2	10	4.900	
CC 14 30	300x140x50	30x30x2	10	5.300	
CC 14 32	320x140x50	30x30x2	10	5.600	
CC 14 34	340x140x50	30x30x2	12	6.000	
CC 14 36	360x140x50	30x30x2	12	6.400	
CC 14 38	380x140x50	30x30x2	12	6.700	
CC 14 40	400x140x50	30x30x2	12	7.000	
CC 18 20	200x180x50	40x30	8	4.550	
CC 18 22	220x180x50	40x30	8	5.000	
CC 18 24	240x180x50	30x30x2	8	5.450	
CC 18 26	260x180x50	30x30x2	8	5.900	
CC 18 28	280x180x50	30x30x2	10	6.350	
CC 18 30	300x180x50	40x30x2	10	6.800	
CC 18 32	320x180x50	40x30x2	10	7.250	
CC 18 34	340x180x50	40x30x2	12	7.700	
CC 18 36	360x180x50	40x30x2	12	8.200	
CC 18 38	380x180x50	40x30x2	12	8.600	
CC 18 40	400x180x50	40x30x2	12	9.000	
CC 22 20	200x220x50	40x30	8	5.550	
CC 22 22	220x220x50	40x30	8	6.100	
CC 22 24	240x220x50	30x30x2	8	6.660	
CC 22 26	260x220x50	30x30x2	8	7.200	
CC 22 28	280x220x50	30x30x2	10	7.800	
CC 22 30	300x220x50	40x30x2	10	8.300	
CC 22 32	320x220x50	40x30x2	10	8.850	
CC 22 34	340x220x50	40x30x2	12	9.450	
CC 22 36	360x220x50	40x30x2	12	10.000	
CC 22 38	380x220x50	40x30x2	12	10.550	
CC 22 40	400x220x50	40x30x2	12	11.200	

Cappa Cubica a parete

Senza motore



Costruzione in acciaio inox AISI 304 .

Accessoriate di filtri in AISI 304 a labirinto facilmente estraibili per il lavaggio periodico.

I filtri a labirinto assicurano una filtrazione costante (senza intasamenti) e sicura (protezione contro il rischio di incendio).

Canalina perimetrale con foro di scarico che convoglia i grassi in una bacinella ai AISI 304.

Tutte le lamiere accessibili dalla mano dell'operatore hanno la doppia piega per evitare ferite.

Predisposte per l'illuminazione.

Dotate di pannelli ciechi in AISI 304 per un giusto bilanciamento dell'aspirazione.

Le dimensioni dei fori di espulsione dell'aria sono dimensionate in modo tale da ridurre al minimo le perdite di carico.

Tutte le cappe sono dotate di bacinella di scarico condensa in AISI 304.

In dotazione golfari, tasselli metallici M8 e staffe di sostegno per la sospensione a soffitto.

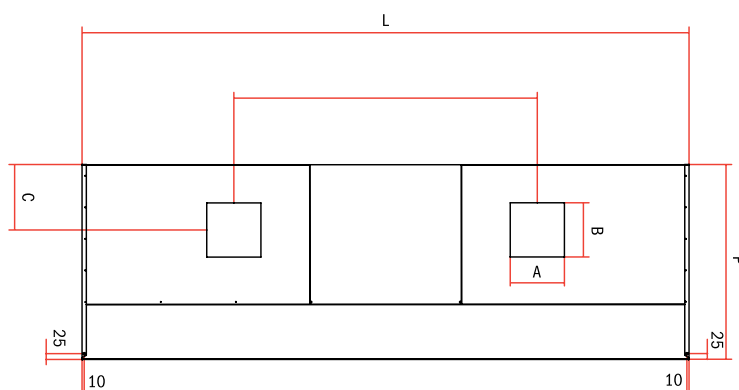
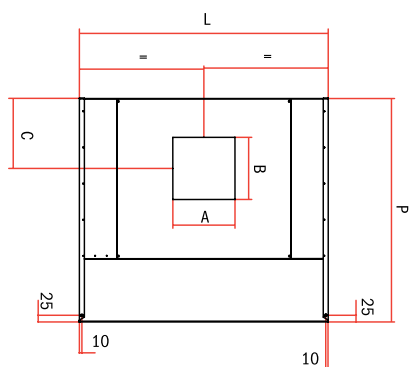
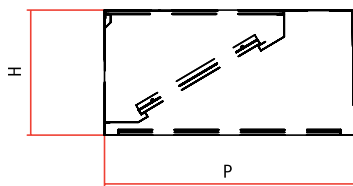

Dimensioni in mm.

CODICE	DIMENSIONI cm	AxB cm	C cm	FILTRI n°	VOLUME MC/H*	
CCP 9 12	120x90x50	20x20	30	2	1.400	
CCP 9 14	140x90x50	25x25	30	3	1.600	
CCP 9 16	160x90x50	30x30	30	3	1.800	
CCP 9 18	180x90x50	30x30	30	3	2.000	
CCP 9 20	200x90x50	30x30	30	4	2.250	
CCP 9 22	220x90x50	30x30	30	4	2.500	
CCP 9 24	240x90x50	30x30	30	4	2.700	
CCP 9 26	260x90x50	30x30x2	30	4	2.950	
CCP 9 28	280x90x50	30x30x2	30	5	3.200	
CCP 9 30	300x90x50	30x30x2	30	5	3.400	
CCP 9 32	320x90x50	30x30x2	30	5	3.650	
CCP 9 34	340x90x50	30x30x2	30	6	3.850	
CCP 9 36	360x90x50	30x30x2	30	6	4.100	
CCP 9 38	380x90x50	30x30x2	30	6	4.300	
CCP 9 40	400x90x50	30x30x2	30	6	4.500	
CCP 11 12	120x110x50	25x25	30	2	1.700	
CCP 11 14	140x110x50	25x25	30	3	1.950	
CCP 11 16	160x110x50	30x30	30	3	2.200	
CCP 11 18	180x110x50	30x30	30	3	2.500	
CCP 11 20	200x110x50	30x30	30	4	2.800	
CCP 11 22	220x110x50	30x30	30	4	3.100	
CCP 11 24	240x110x50	30x30x2	30	4	3.400	
CCP 11 26	260x110x50	30x30x2	30	4	3.600	
CCP 11 28	280x110x50	30x30x2	30	5	3.900	
CCP 11 30	300x110x50	30x30x2	30	5	4.200	
CCP 11 32	320x110x50	30x30x2	30	5	4.500	
CCP 11 34	340x110x50	30x30x2	30	6	4.700	
CCP 11 36	360x110x50	30x30x2	30	6	5.000	
CCP 11 38	380x110x50	30x30x2	30	6	5.300	
CCP 11 40	400x110x50	30x30x2	30	6	5.600	
CCP 14 12	120x140x50	25x25	30	2	2.100	
CCP 14 14	140x140x50	25x25	30	3	2.500	
CCP 14 16	160x140x50	30x30	30	3	2.800	
CCP 14 18	180x140x50	30x30	30	3	3.200	
CCP 14 20	200x140x50	30x30	30	4	3.500	
CCP 14 22	220x140x50	30x30	30	4	3.900	
CCP 14 24	240x140x50	30x30x2	30	4	4.200	
CCP 14 26	260x140x50	30x30x2	30	4	4.600	
CCP 14 28	280x140x50	30x30x2	30	5	4.900	
CCP 14 30	300x140x50	30x30x2	30	5	5.300	
CCP 14 32	320x140x50	30x30x2	30	5	5.600	
CCP 14 34	340x140x50	30x30x2	30	6	6.000	
CCP 14 36	360x140x50	30x30x2	30	6	6.400	
CCP 14 38	380x140x50	30x30x2	30	6	6.700	
CCP 14 40	400x140x50	30x30x2	30	6	7.000	

Cappa Cubica centrale

Senza motore



Costruzione in acciaio inox AISI 304 .

Accessorate di filtri in AISI 304 a labirinto facilmente estraibili per il lavaggio periodico.

I filtri a labirinto assicurano una filtrazione costante (senza intasamenti) e sicura (protezione contro il rischio di incendio).

Canalina perimetrale con foro di scarico che convoglia i grassi in una bacinella ai AISI 304.

Tutte le lamiere accessibili dalla mano dell'operatore hanno la doppia piega per evitare ferite.

Predisposte per l'illuminazione.

Dotate di pannelli ciechi in AISI 304 per un giusto bilanciamento dell'aspirazione.

Le dimensioni dei fori di espulsione dell'aria sono dimensionate in modo tale da ridurre al minimo le perdite di carico.

Tutte le cappe sono dotate di bacinella di scarico condensa in AISI 304.

In dotazione golfari, tasselli metallici M8 e staffe di sostegno per la sospensione a soffitto.

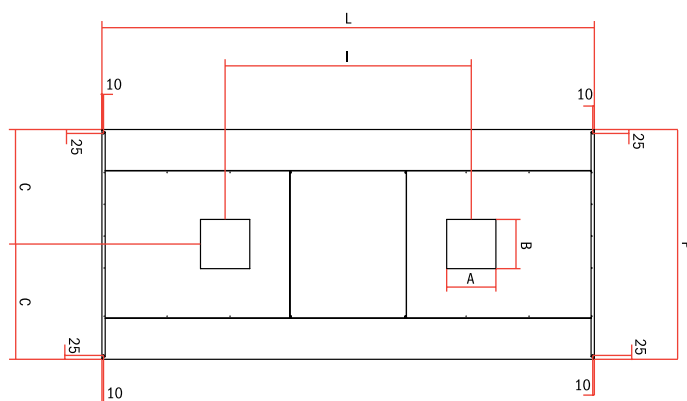
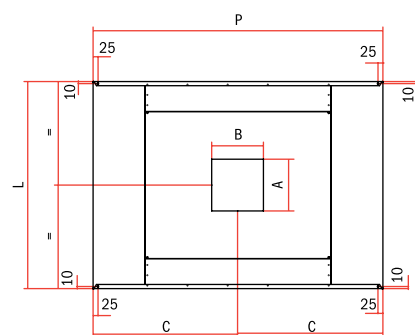
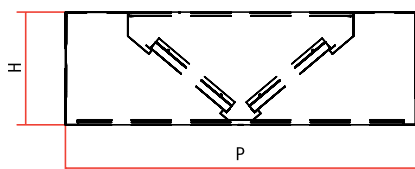

Dimensioni in mm.

CODICE	DIMENSIONI cm	AxB cm	C cm	FILTRI n°	VOLUME MC/H*	
CCC 14 12	120x140x50	25x25	70	4	2.100	
CCC 14 14	140x140x50	25x25	70	4	2.500	
CCC 14 16	160x140x50	30x30	70	6	2.800	
CCC 14 18	180x140x50	30x30	70	6	3.200	
CCC 14 20	200x140x50	30x30	70	8	3.500	
CCC 14 22	220x140x50	40x30	70	8	3.950	
CCC 14 24	240x140x50	40x30	70	8	4.200	
CCC 14 26	260x140x50	40x30	70	8	4.600	
CCC 14 28	280x140x50	30x30x2	70	10	4.900	
CCC 14 30	300x140x50	30x30x2	70	10	5.300	
CCC 14 32	320x140x50	30x30x2	70	10	5.600	
CCC 14 34	340x140x50	30x30x2	70	12	6.000	
CCC 14 36	360x140x50	30x30x2	70	12	6.400	
CCC 14 38	380x140x50	30x30x2	70	12	6.700	
CCC 14 40	400x140x50	30x30x2	70	12	7.200	
CCC 18 12	120x180x50	30x30	90	4	2.750	
CCC 18 14	140x180x50	30x30	90	6	3.200	
CCC 18 16	160x180x50	30x30	90	6	3.650	
CCC 18 18	180x180x50	40x30	90	6	4.050	
CCC 18 20	200x180x50	40x30	90	8	4.550	
CCC 18 22	220x180x50	40x30	90	8	5.000	
CCC 18 24	240x180x50	30x30x2	90	8	5.450	
CCC 18 26	260x180x50	30x30x2	90	8	5.900	
CCC 18 28	280x180x50	30x30x2	90	10	6.350	
CCC 18 30	300x180x50	30x30x2	90	10	6.800	
CCC 18 32	320x180x50	30x30x2	90	10	7.250	
CCC 18 34	340x180x50	30x30x2	90	12	7.700	
CCC 18 36	360x180x50	40x30x2	90	12	8.200	
CCC 18 38	380x180x50	40x30x2	90	12	8.600	
CCC 18 40	400x180x50	40x30x2	90	12	9.000	
CCC 22 12	120x220x50	30x30	110	4	3.300	
CCC 22 14	140x220x50	30x30	110	6	3.900	
CCC 22 16	160x220x50	40x30	110	6	4.450	
CCC 22 18	180x220x50	40x30	110	6	5.000	
CCC 22 20	200x220x50	40x30	110	8	5.550	
CCC 22 22	220x220x50	40x30	110	8	6.000	
CCC 22 24	240x220x50	30x30x2	110	8	6.660	
CCC 22 26	260x220x50	30x30x2	110	8	7.200	
CCC 22 28	280x220x50	30x30x2	110	10	7.800	
CCC 22 30	300x220x50	40x30x2	110	10	8.100	
CCC 22 32	320x220x50	40x30x2	110	10	8.850	
CCC 22 34	340x220x50	40x30x2	110	12	9.450	
CCC 22 36	360x220x50	40x30x2	110	12	10.000	
CCC 22 38	380x220x50	40x30x2	110	12	10.500	
CCC 22 40	400x140x50	40x30x2	110	12	11.000	

Cappa Vapor

Senza motore



Costruzione in acciaio inox AISI 304 .

Accessoriate di filtri in AISI 304 a labirinto facilmente estraibili per il lavaggio periodico.

I filtri a labirinto assicurano una filtrazione costante (senza intasamenti) e sicura (protezione contro il rischio di incendio).

Canalina perimetrale con foro di scarico che convoglia i grassi in una bacinella ai AISI 304.

Tutte le lamiere accessibili dalla mano dell'operatore hanno la doppia piega per evitare ferite.

Predisposte per l'illuminazione.

Dotate di pannelli ciechi in AISI 304 per un giusto bilanciamento dell'aspirazione.

Le dimensioni dei fori di espulsione dell'aria sono dimensionate in modo tale da ridurre al minimo le perdite di carico.

Tutte le cappe sono dotate di bacinella di scarico condensa (in AISI 304) $\varnothing=3/8''$.

In dotazione golfari, tasselli metallici M8 e staffe di sostegno per la sospensione a soffitto.

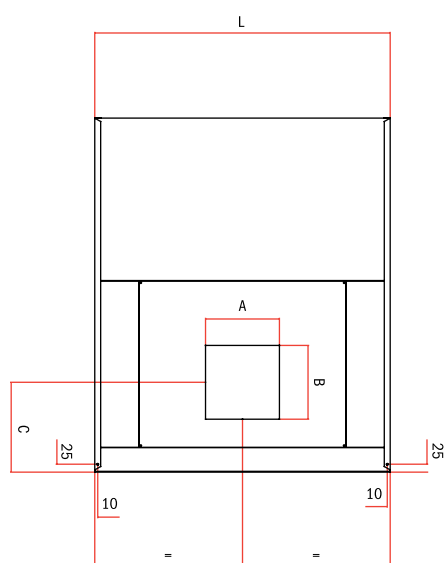
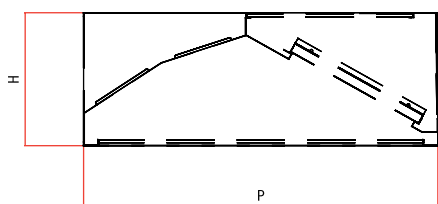

Dimensioni in mm.

CODICE	DIMENSIONI cm	AxB cm	C cm	FILTRI n°	VOLUME MC/H*	
CVP 12 10	100x120x50	25x25	30	2	1.300	
CVP 12 12	120x120x50	25x25	30	2	1.550	
CVP 12 14	140x120x50	25x25	30	3	1.800	
CVP 12 16	160x120x50	30x30	30	3	2.100	
CVP 12 18	180x120x50	30x30	30	3	2.350	
CVP 12 20	200x120x50	30x30	30	4	2.600	
CVP 14 10	100x140x50	25x25	30	2	1.500	
CVP 14 12	120x140x50	25x25	30	2	1.800	
CVP 14 14	140x140x50	25x25	30	3	2.100	
CVP 14 16	160x140x50	30x30	30	3	2.400	
CVP 14 18	180x140x50	30x30	30	3	2.750	
CVP 14 20	200x140x50	30x30	30	4	3.000	

**CAPPE
CON
MOTORE**

Cappa Snack a parete

Con motore



Costruzione in acciaio inox AISI 304 .

Accessoriate di filtri in AISI 304 a labirinto facilmente estraibili per il lavaggio periodico.

I filtri a labirinto assicurano una filtrazione costante (senza intasamenti) e sicura (protezione contro il rischio di incendio).

Canalina posteriore con foro di scarico che convoglia i grassi in una bacinella ai AISI 304.

Tutte le lamiere accessibili dalla mano dell'operatore hanno la doppia piega per evitare ferite.

Predisposte per l'illuminazione.

Dotate di pannelli ciechi in AISI 304 per un giusto bilanciamento dell'aspirazione.

Le dimensioni dei fori di espulsione dell'aria sono dimensionate in modo tale da ridurre al minimo le perdite di carico.

Tutte le cappe sono dotate di ventilatore interno (due per le lunghezze superiori a 280 cm) con potenza pari a 550W.

Tutte le cappe sono dotate di bacinella di scarico condensa in AISI 304.

In dotazione golfari, tasselli metallici M8 e staffe di sostegno per la sospensione a soffitto.

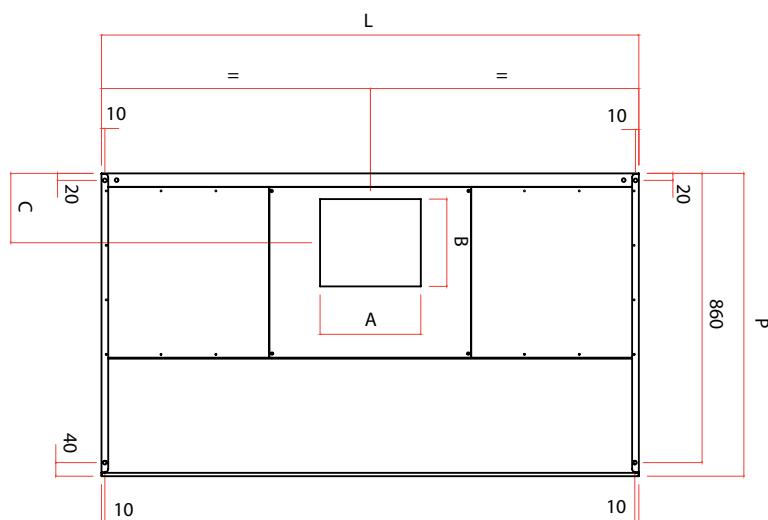
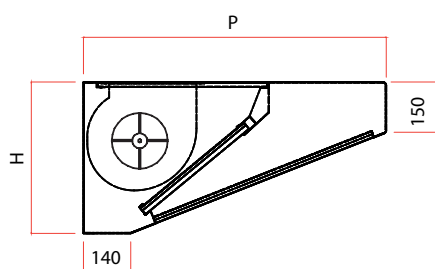

Dimensioni in mm.

CODICE	DIMENSIONI cm	AxB cm	C cm	FILTRI n°	TIPO MOTORE	WATT/ AMP	
CSPM 9 10	100x90x50	23x20	23	2	7/7	145/1,8	
CSPM 9 12	120x90x50	23x20	23	2	7/7	145/1,8	
CSPM 9 14	140x90x50	23x20	23	2	7/7	145/1,8	
CSPM 9 16	160x90x50	30x26	21	3	9/9T	300/4,1	
CSPM 9 18	180x90x50	30x26	21	3	9/9T	300/4,1	
CSPM 9 20	200x90x50	30x26	21	4	9/9T	300/4,1	
CSPM 9 22	220x90x50	30x26	21	4	9/9T	300/4,1	
CSPM 9 24	240x90x50	30x26	21	4	8/9T	420/3,1	
CSPM 9 26	260x90x50	30x26	21	4	8/9T	420/3,1	
CSPM 9 28	280x90x50	30x26	21	5	8/9T	420/3,1	
CSPM 9 30	300x90x50	30x26	21	5	8/9T	420/3,1	
CSPM 11 12	120x110x50	23x20	23	2	7/7	145/1,8	
CSPM 11 14	140x110x50	30x26	21	2	9/9T	300/4,1	
CSPM 11 16	160x110x50	30x26	21	3	9/9T	300/4,1	
CSPM 11 18	180x110x50	30x26	21	3	9/9T	300/4,1	
CSPM 11 20	200x110x50	30x26	21	4	8/9T	420/3,1	
CSPM 11 22	220x110x50	30x26	21	4	8/9T	420/3,1	
CSPM 11 24	240x110x50	30x26	21	4	8/9T	420/3,1	
CSPM 11 26	260x110x50	30x26	21	4	8/9T	420/3,1	
CSPM 11 28	280x110x50	30x26	21	5	8/9T	420/3,1	
CSPM 11 30	300x110x50	30x26	21	5	8/9T	420/3,1	

Cappa Snack centrale

Con motore

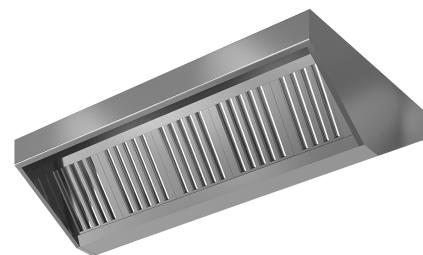

Costruzione in acciaio inox AISI 304 .

Accessoriate di filtri in AISI 304 a labirinto facilmente estraibili per il lavaggio periodico.

I filtri a labirinto assicurano una filtrazione costante (senza intasamenti) e sicura (protezione contro il rischio di incendio).

Canalina centrale con foro di scarico che convoglia i grassi in una bacinella ai AISI 304.

Tutte le lamiere accessibili dalla mano dell'operatore hanno la doppia piega per evitare ferite.

Predisposte per l'illuminazione.

Dotate di pannelli ciechi in AISI 304 per un giusto bilanciamento dell'aspirazione.

Le dimensioni dei fori di espulsione dell'aria sono dimensionate in modo tale da ridurre al minimo le perdite di carico.

Tutte le cappe sono dotate di ventilatore interno (due per le lunghezze superiori a 280 cm) con potenza pari a 550W.

Tutte le cappe sono dotate di bacinella di scarico condensa in AISI 304.

In dotazione golfari, tasselli metallici M8 e staffe di sostegno per la sospensione a soffitto.

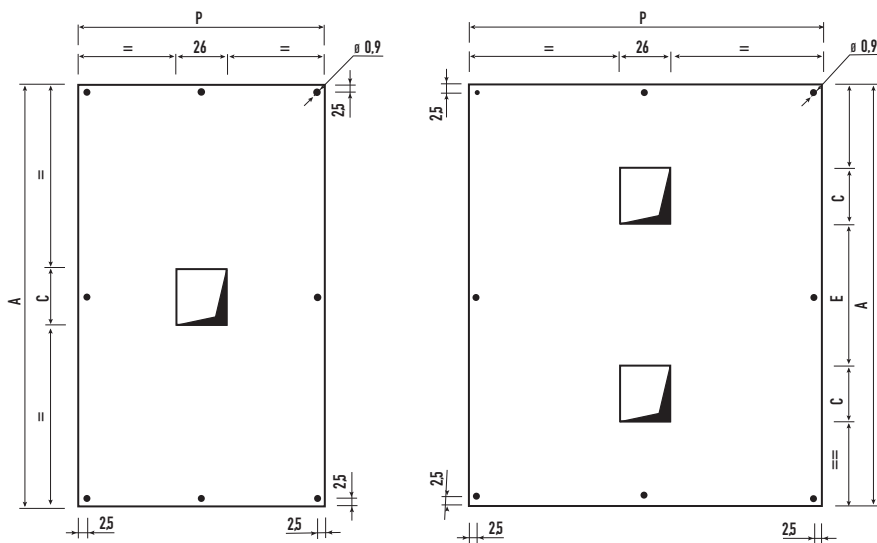
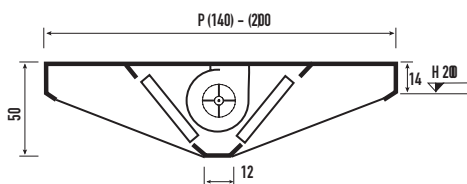

Dimensioni in Cm.

CODICE	DIMENSIONI cm	AxB cm	C cm	FILTRI n°	TIPO MOTORE	WATT/ AMP	
CSCM 12 12	120x120x50	30x26	67	4	9/9T	300/4,1	
CSCM 12 14	140x120x50	30x26	67	4	9/9T	300/4,1	
CSCM 12 16	160x120x50	30x26	67	6	9/9T	300/4,1	
CSCM 12 18	180x120x50	30x26	67	6	9/9T	300/4,1	
CSCM 12 10	200x120x50	30x26	67	8	8/9T	420/3,1	
CSCM 14 12	120x140x50	30x26	77	4	9/9T	300/4,1	
CSCM 14 14	140x140x50	30x26	77	4	9/9T	300/4,1	
CSCM 14 16	160x140x50	30x26	77	6	9/9T	300/4,1	
CSCM 14 18	180x140x50	30x26	77	6	8/9T	420/3,1	
CSCM 14 20	200x140x50	30x26	77	8	8/9T	420/3,1	

Cappa a parete

Con motore



Costruzione in acciaio inox AISI 304 .

Accessoriate di filtri in AISI 304 a labirinto facilmente estraibili per il lavaggio periodico.

I filtri a labirinto assicurano una filtrazione costante (senza intasamenti) e sicura (protezione contro il rischio di incendio).

Canalina perimetrale con foro di scarico che convoglia i grassi in una bacinella ai AISI 304.

Tutte le lamiere accessibili dalla mano dell'operatore hanno la doppia piega per evitare ferite.

Predisposte per l'illuminazione.

Dotate di pannelli ciechi in AISI 304 per un giusto bilanciamento dell'aspirazione.

Tutte le cappe sono dotate di ventilatore interno (due per le lunghezze superiori a 280 cm) con potenza pari a 550W.

Passacavo elettrico sul tetto delle cappe.

Le dimensioni dei fori di espulsione dell'aria sono dimensionate in modo tale da ridurre al minimo le perdite di carico.

Tutte le cappe sono dotate di bacinella di scarico condensa in AISI 304.

In dotazione golfari, tasselli metallici M8 e staffe di sostegno per la sospensione a soffitto.

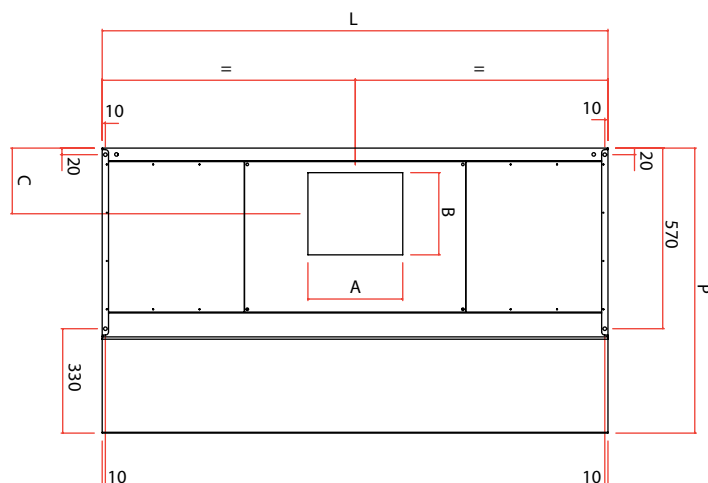
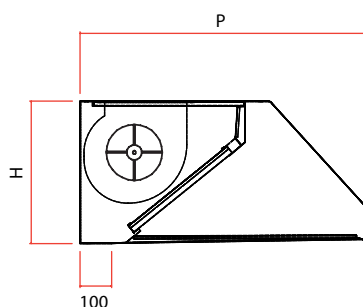

Dimensioni in mm.

CODICE	DIMENSIONI cm	AxB cm	C cm	FILTRI n°	TIPO MOTORE	WATT/ AMP	
CPM 9 10	100x90x50	23x20	23	2	7/7	145/1,8	
CPM 9 12	120x90x50	23x20	23	2	7/7	145/1,8	
CPM 9 14	140x90x50	23x20	23	2	7/7	145/1,8	
CPM 9 16	160x90x50	30x26	21	3	9/9T	300/4,1	
CPM 9 18	180x90x50	30x26	21	3	9/9T	300/4,1	
CPM 9 20	200x90x50	30x26	21	4	9/9T	300/4,1	
CPM 9 22	220x90x50	30x26	21	4	9/9T	300/4,1	
CPM 9 24	240x90x50	30x26	21	4	8/9T	420/3,1	
CPM 9 26	260x90x50	30x26	21	4	8/9T	420/3,1	
CPM 9 28	280x90x50	30x26	21	5	8/9T	420/3,1	
CPM 9 30	300x90x50	30x26	21	5	8/9T	420/3,1	
CPM 11 12	120x110x50	23x20	23	2	7/7	145/1,8	
CPM 11 14	140x110x50	30x26	21	2	9/9T	300/4,1	
CPM 11 16	160x110x50	30x26	21	3	9/9T	300/4,1	
CPM 11 18	180x110x50	30x26	21	3	9/9T	300/4,1	
CPM 11 20	200x110x50	30x26	21	4	8/9T	420/3,1	
CPM 11 22	220x110x50	30x26	21	4	8/9T	420/3,1	
CPM 11 24	240x110x50	30x26	21	4	8/9T	420/3,1	
CPM 11 26	260x110x50	30x26	21	4	8/9T	420/3,1	
CPM 11 28	280x110x50	30x26	21	5	8/9T	420/3,1	
CPM 11 30	300x110x50	30x26	21	5	8/9T	420/3,1	

Cappa centrale

Con motore



Costruzione in acciaio inox AISI 304 .

Accessoriate di filtri in AISI 304 a labirinto facilmente estraibili per il lavaggio periodico.

I filtri a labirinto assicurano una filtrazione costante (senza intasamenti) e sicura (protezione contro il rischio di incendio).

Canalina perimetrale con foro di scarico che convoglia i grassi in una bacinella ai AISI 304.

Tutte le lamiere accessibili dalla mano dell'operatore hanno la doppia piega per evitare ferite.

Predisposte per l'illuminazione.

Dotate di pannelli ciechi in AISI 304 per un giusto bilanciamento dell'aspirazione.

Tutte le cappe sono dotate di ventilatore interno (due per le lunghezze superiori a 280 cm) con potenza pari a 550W.

Passacavo elettrico sul tetto delle cappe.

Le dimensioni dei fori di espulsione dell'aria sono dimensionate in modo tale da ridurre al minimo le perdite di carico.

Tutte le cappe sono dotate di bacinella di scarico condensa in AISI 304.

In dotazione golfari, tasselli metallici M8 e staffe di sostegno per la sospensione a soffitto.

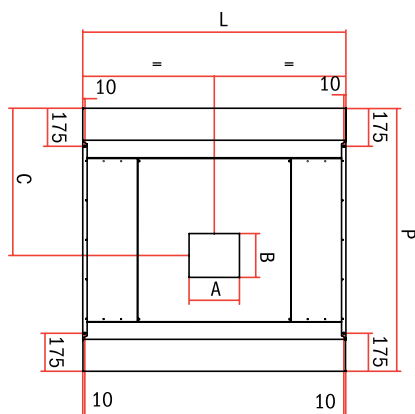
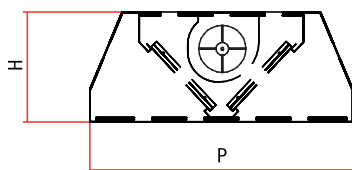

Dimensioni in mm.

CODICE	DIMENSIONI cm	AxB cm	C cm	FILTRI n°	TIPO MOTORE	WATT/ AMP	
CCM 12 12	120x120x50	30x26	67	4	9/9T	300/4,1	
CCM 12 14	140x120x50	30x26	67	4	9/9T	300/4,1	
CCM 12 16	160x120x50	30x26	67	6	8/9T	420/3,1	
CCM 12 18	180x120x50	30x26	67	6	8/9T	420/3,1	
CCM 12 20	200x120x50	30x26	67	8	8/9T	420/3,1	
CCM 14 12	120x140x50	30x26	77	4	9/9T	300/4,1	
CCM 14 14	140x140x50	30x26	77	4	9/9T	300/4,1	
CCM 14 16	160x140x50	30x26	77	6	8/9T	420/3,1	
CCM 14 18	180x140x50	30x26	77	6	8/9T	420/3,1	
CCM 14 20	200x140x50	30x26	77	8	8/9T	420/3,1	

Cappa Cubica a parete

Con motore



Costruzione in acciaio inox AISI 304 .

Accessoriate di filtri in AISI 304 a labirinto facilmente estraibili per il lavaggio periodico.

I filtri a labirinto assicurano una filtrazione costante (senza intasamenti) e sicura (protezione contro il rischio di incendio).

Canalina perimetrale con foro di scarico che convoglia i grassi in una bacinella ai AISI 304.

Tutte le lamiere accessibili dalla mano dell'operatore hanno la doppia piega per evitare ferite.

Predisposte per l'illuminazione.

Dotate di pannelli ciechi in AISI 304 per un giusto bilanciamento dell'aspirazione.

Tutte le cappe sono dotate di ventilatore interno (due per le lunghezze superiori a 280 cm) con potenza pari a 550W.

Passacavo elettrico sul tetto delle cappe.

Le dimensioni dei fori di espulsione dell'aria sono dimensionate in modo tale da ridurre al minimo le perdite di carico.

Tutte le cappe sono dotate di bacinella di scarico condensa in AISI 304.

In dotazione golfari, tasselli metallici M8 e staffe di sostegno per la sospensione a soffitto.

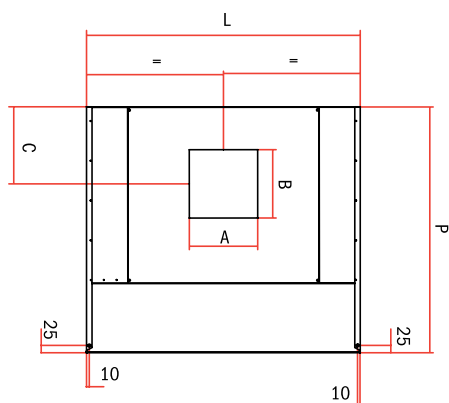
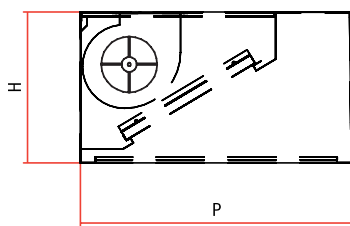

Dimensioni in mm.

CODICE	DIMENSIONI cm	AxB cm	C cm	FILTRI n°	TIPO MOTORE	WATT/ AMP	
CCPM 9 10	100X90X50	23x20	24,5	2	7/7	184/1,8	
CCPM 9 12	120X90X50	23x20	24,5	2	7/7	184/1,8	
CCPM 9 14	140X90X50	23x20	24,5	3	7/7	184/1,8	
CCPM 9 16	160X90X50	30x27	21,5	3	8/9T	420/3,8	
CCPM 9 18	180X90X50	30x27	21,5	3	8/9T	420/3,8	
CCPM 9 20	200X90X50	30x27	21,5	4	8/9T	420/3,8	
CCPM 9 22	220X90X50	30x27	21,5	4	8/9T	420/3,8	
CCPM 9 24	240X90X50	30x27	21,5	4	8/9T	420/3,8	
CCPM 9 26	260X90X50	30x27	21,5	4	8/9T	420/3,8	
CCPM 9 28	280X90X50	30x27	21,5	5	8/9T	420/3,8	
CCPM 9 30	300X90X50	30x27	21,5	5	8/9T	420/3,8	
CCPM 11 12	120x110x50	23x20	24,5	2	7/7	184/1,8	
CCPM 11 14	140x110x50	30x27	21,5	3	8/9T	420/3,8	
CCPM 11 16	160x110x50	30x27	21,5	3	8/9T	420/3,8	
CCPM 11 18	180x110x50	30x27	21,5	3	8/9T	420/3,8	
CCPM 11 20	200x110x50	30x27	21,5	4	8/9T	420/3,8	
CCPM 11 22	220x110x50	30x27	21,5	4	8/9T	420/3,8	
CCPM 11 24	240x110x50	30x27	21,5	4	8/9T	420/3,8	
CCPM 11 26	260x110x50	30x27	21,5	4	8/9T	420/3,8	
CCPM 11 28	280x110x50	30x27	21,5	5	8/9T	420/3,8	
CCPM 11 30	300x110x50	30x27	21,5	5	8/9T	420/3,8	
CCPM 14 12	120x140x50	30x27	90	4	8/9T	420/3,8	
CCPM 14 14	140x140x50	30x27	90	4	8/9T	420/3,8	
CCPM 14 16	160x140x50	30x27	90	6	8/9T	420/3,8	
CCPM 14 18	180x140x50	30x27	90	6	8/9T	420/3,8	
CCPM 14 20	200x140x50	30x27	90	8	8/9T	420/3,8	

Cappa Cubica centrale

Con motore



Costruzione in acciaio inox AISI 304 .

Accessoriate di filtri in AISI 304 a labirinto facilmente estraibili per il lavaggio periodico.

I filtri a labirinto assicurano una filtrazione costante (senza intasamenti) e sicura (protezione contro il rischio di incendio).

Canalina perimetrale con foro di scarico che convoglia i grassi in una bacinella ai AISI 304.

Tutte le lamiere accessibili dalla mano dell'operatore hanno la doppia piega per evitare ferite.

Predisposte per l'illuminazione.

Dotate di pannelli ciechi in AISI 304 per un giusto bilanciamento dell'aspirazione.

Tutte le cappe sono dotate di ventilatore interno (due per le lunghezze superiori a 280 cm) con potenza pari a 550W.

Passacavo elettrico sul tetto delle cappe.

Le dimensioni dei fori di espulsione dell'aria sono dimensionate in modo tale da ridurre al minimo le perdite di carico.

Tutte le cappe sono dotate di bacinella di scarico condensa in AISI 304.

In dotazione golfari, tasselli metallici M8 e staffe di sostegno per la sospensione a soffitto.

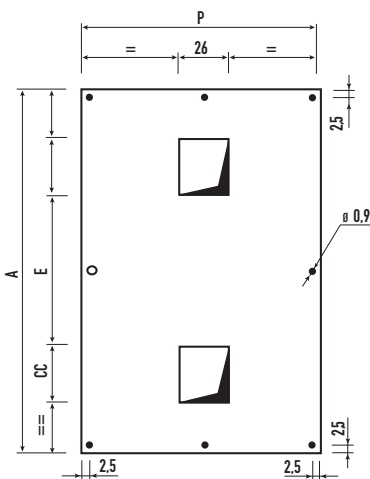
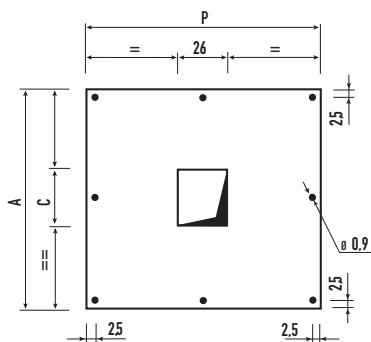
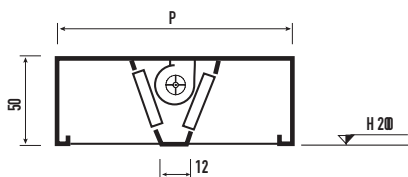

Dimensioni in Cm.

CODICE	DIMENSIONI cm	AxB cm	C cm	FILTRI n°	TIPO MOTORE	WATT/ AMP	
CCCM 12 12	120x120x50	30x27	67	4	8/9T	420/3,8	
CCCM 12 16	140x120x50	30x27	67	4	8/9T	420/3,8	
CCCM 14 16	160x120x50	30x27	67	6	8/9T	420/3,8	
CCCM 14 18	180x120x50	30x27	67	6	8/9T	420/3,8	
CCCM 14 20	200x120x50	30x27	67	8	8/9T	420/3,8	
CCCM 14 12	120x140x50	30x27	90	4	8/9T	420/3,8	
CCCM 14 14	140x140x50	30x27	90	4	8/9T	420/3,8	
CCCM 14 16	160x140x50	30x27	90	6	8/9T	420/3,8	
CCCM 14 18	180x140x50	30x27	90	6	8/9T	420/3,8	
CCCM 14 20	200x140x50	30x27	90	8	8/9T	420/3,8	

Cappa Vapor

Con motore



Costruzione in acciaio inox AISI 304 .

Accessoriate di filtri in AISI 304 a labirinto facilmente estraibili per il lavaggio periodico.

I filtri a labirinto assicurano una filtrazione costante (senza intasamenti) e sicura (protezione contro il rischio di incendio).

Canalina perimetrale con foro di scarico che convoglia i grassi in una bacinella ai AISI 304.

Tutte le lamiere accessibili dalla mano dell'operatore hanno la doppia piega per evitare ferite.

Predisposte per l'illuminazione.

Dotate di pannelli ciechi in AISI 304 per un giusto bilanciamento dell'aspirazione.

Le dimensioni dei fori di espulsione dell'aria sono dimensionate in modo tale da ridurre al minimo le perdite di carico.

Tutte le cappe sono dotate di bacinella di scarico condensa (in AISI 304) $\varnothing=3/8''$.

In dotazione golfari, tasselli metallici M8 e staffe di sostegno per la sospensione a soffitto.

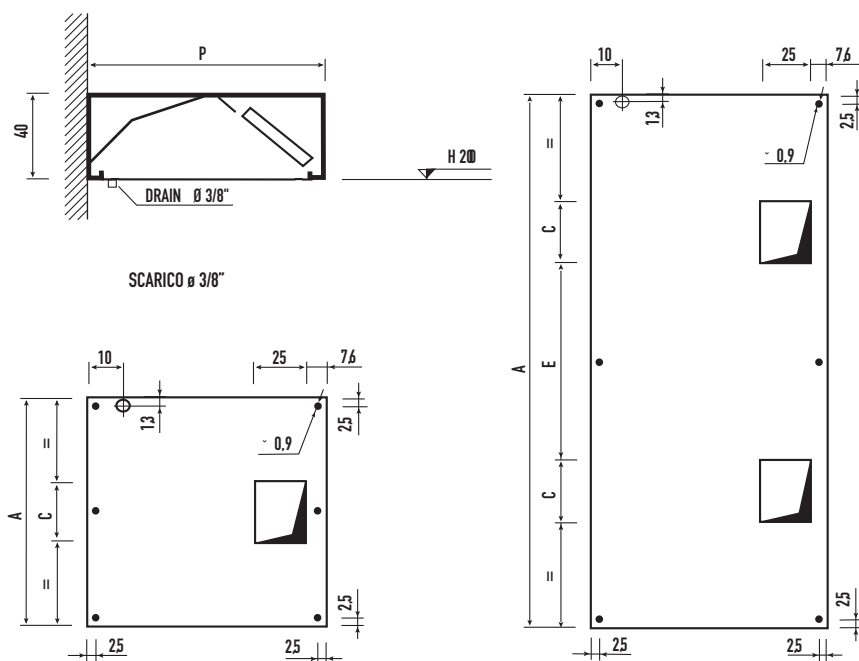

Dimensioni in Cm.

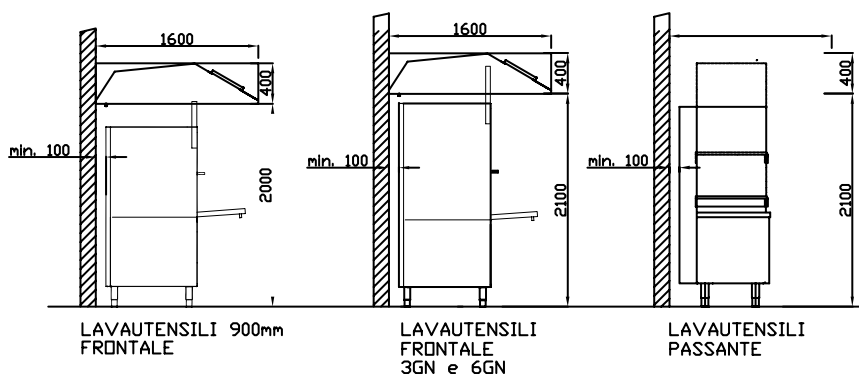

CODICE	DIMENSIONI cm	AxB cm	C cm	TIPO MOTORE	WATT/ AMP	
CVPM 10 10	100x100x50	23x20	240	7/7	145/1,8	
CVPM 10 12	120x100x50	23x20	240	7/7	145/1,8	
CVPM 10 14	140x100x50	23x20	240	7/7	145/1,8	
CVPM 10 16	160x100x50	23x20	240	7/7	145/1,8	
CVPM 10 18	180x100x50	30x26	210	9/9T	300/4,1	
CVPM 10 20	200x100x50	30x26	210	9/9T	300/4,1	
CVPM 12 10	100x120x50	23x20	240	7/7	145/1,8	
CVPM 12 12	120x120x50	23x20	240	7/7	145/1,8	
CVPM 12 14	140x120x50	23x20	240	7/7	145/1,8	
CVPM 12 16	160x120x50	30x26	210	9/9T	300/4,1	
CVPM 12 18	180x120x50	30x26	210	9/9T	300/4,1	
CVPM 12 20	200x120x50	30x26	210	9/9T	300/4,1	

ACCESSORI CAPPE

Plenum

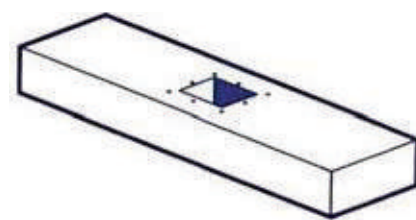

CODICE	DIMENSIONI cm	Acciaio inox AISI 304	Lamiera Zincata
PLE 18	500x180x400		
PLE 20	500x200x400		
PLE 22	500x220x400		
PLE 24	500x240x400		
PLE 26	500x260x400		
PLE 28	500x280x400		
PLE 30	500x300x400		

Regolatore di Velocità digitale a parete

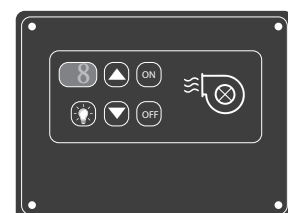

CODICE	DIMENSIONI cm	VOLT	IP	AMP.
RVD 45	153x110x66	230	52	4,5
RVD 100	153x110x66	230	52	10

Inverter con comando remoto



CODICE	DIMENSIONI cm	VOLT	KW
INV 15	153x110x66	400	1,5
INV 22	153x110x66	400	2,2
INV 20	153x110x66	400	3

Plafoniera



CODICE	POTENZA	TIPOLOGIA	
PL T5 28	1x36 W	T5	
PL T5 35	1x58 W	T5	

Flange di attacco

da quadro a tondo



CODICE	DIMENSIONI	
FLA 20 30	ø20 x 30x30	
FLA 25 35	ø25 x 35x35	
FLA 30 40	ø30 x 40x40	
FLA 35 45	ø35 x 45x45	
FLA 40 50	ø40 x 50x50	
FLA 50 60	ø50 x 60x60	
FLA 60 70	ø60 x 70x70	

Filtri a labirinto

in acciaio inox Aisi 304



CODICE	DIMENSIONI	
FILA	400x500x25	

VENTILAZIONE

LINEA ASPIRAZIONE

Ventilatore Cassonato

con motore direttamente accoppiato



CODICE	DIMENSIONI cm	M3/H	HST	KW	
VCC 7/7-4	50x50x50	1.300	16	0,147	
VCC 9/7-4	50x50x50	2.000	42	0,373	
VCC 9/9-4	60x60x60	2.200	37	0,373	
VCC 10/10-4	60x60x60	3.600	42	0,55	
VCC12/9 -6M	75x75x75	3.500	30	0,59	
VCC 12/12-6M	75x75x75	4.250	33	0,59	
VCC 12/9-6T	75x75x75	4.800	27	1,1	
VCC 12/12-6T	75x75x75	6.500	25	1,1	

Ventilatore Cassonato

Motore con trasmissione a cinghia ad 1 velocità



CODICE	DIMENSIONI cm	M3/H	HST	KW	
VTC 7/7 A	50x70x50	800	15	0,18	
VTC 7/7 B	50x70x50	1.200	25	0,25	
VTC 7/7 C	50x70x50	1.800	35	0,55	
VTC 9/7 A	50x70x50	1.500	50	0,55	
VTC 9/7 B	50x70x50	2.500	50	0,75	
VTC 9/9 A	60x80x60	2.300	30	0,37	
VTC 9/9 B	60x80x60	2.800	35	0,55	
VTC 9/9 C	60x80x60	3.300	40	0,75	
VTC 10/8 A	60x80x60	3.100	50	1,1	
VTC 10/8 B	62x80x62	4.000	50	1,5	
VTC 10/10 A	60x80x60	3.100	25	0,55	
VTC 10/10 B	60x80x60	3.600	30	0,75	
VTC 10/10 C	60x80x60	4.100	42	1,1	
VTC 10/10 D	62x80x62	4.600	40	1,5	
VTC 12/9 A	75x90x75	4.300	50	1,1	
VTC 12/9 B	75x90x75	5.200	50	1,5	
VTC 12/12 A	75x90x75	4.800	25	0,75	
VTC 12/12 B	75x90x75	6.200	35	1,5	
VTC 12/12 C	75x90x75	7.400	40	2,2	
VTC 15/11 A	90x100x90	6.900	50	2,2	
VTC 15/11 B	90x100x90	8.000	60	3	
VTC 15/15 A	90x100x90	8.000	30	1,5	
VTC 15/15 B	90x100x90	9.000	35	2,2	
VTC 15/15 C	90x100x90	10.000	40	3	
VTC 18/13 A	100x120x100	10.000	55	3	
VTC 18/13 B	100x120x100	12.000	55	4	
VTC 18/18 A	100x100x100	10.500	25	1,5	
VTC 18/18 B	100x120x100	13.600	35	3	
VTC 18/18 C	100x120x100	15.000	40	4	

Ventilatore Cassonato

Motore con trasmissione a cinghia a 2 velocità



CODICE	DIMENSIONI cm	M3/H	HST	KW	
VTCD 7/7	50x70x50	1.800	35	0,55-0,16	
VTCD 9/7	50x70x50	2500	50	0,75-0,25	
VTCD 9/9	60x80x60	3.300	40	0,75-0,25	
VTCD 10/8	62x60x62	4.000	50	1,7-0,6	
VTCD 10/10	60x80x60	4.100	42	1,1-0,37	
VTCD 12/9	75x90x75	5.200	50	1,7-0,6	
VTCD 12/12	75x90x75	7.400	40	2,2-0,75	
VTCD 15/11	90x100x90	8.000	60	3-1	
VTCD 15/15	90x100x90	10.000	40	3-1	
VTCD 18/13	100x120x100	12.000	55	4-1,2	
VTCD 18/18	100x120x100	15.000	40	4-1,2	

Centralina a carbone attivo

per abbattimento odori



CODICE	DIMENSIONI cm	M3/H	HST	KW	FILTRI	
CDA 45	98x185x75	4.500	21	1,5	15	
CDA 60	128x175x80	6.000	25	2,2	18	
CDA 75	159x175x80	7.500	27	3	24	
CDA 90	128x185x98	9.000	18	3	24	
CDA 12	128x185x128	12.000	15	4	29	

Gruppo di filtrazione e deodorizzazione per cassonati



CODICE	DIMENSIONI cm
GFC 115	40x67x80
GFC 130	67x67x80

Centralina a carbone attivo per abbattimento odori



CODICE	DIMENSIONI cm	M3/H	HST	KW
CDAE 30	67x235x69	3.000	20	1,5
CDAE 45	98x145x75	4.500	20	3
CDAE 60	128x230x80	6.000	25	3
CDAE 75	159x230x85	7.500	30	4
CDAE 90	128x290x105	9.000	30	4
CDAE 120	128x290x128	12.000	25	5

Centralina a carbone attivo monofase per abbattimento odori

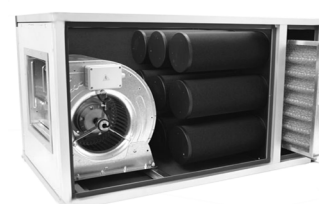

CODICE	DIMENSIONI cm	M3/H	HST	KW	FILTRI
CDAM 115	67x110x43	1.500	10	0,42	5
CDAM 130	67x120x67	3.000	18	0,55	9

Filtri a cella ondulata

Cella filtrante ondulata in fibra sintetica

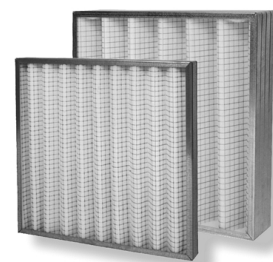

CODICE	DIMENSIONI	
FILCOS A	287x592x48	
FILCOS B	592x592x48	

Filtri a cella ondulata

Cella filtrante ondulata in maglia metallica



CODICE	DIMENSIONI	
FILCOM A	287x592x48	
FILCOM B	592x592x48	

Filtri a tasche termosaldate



CODICE	DIMENSIONI	
FILTT A	287x592x500	
FILTT B	592x592x500	

Carbone attivo di origine vegetale



CODICE	
CAR	



**Sede Legale: Via Ospedalicchio, 3
74021 Taranto**

**Sede Operativa: Via del Tratturello Del Tarantino, 6
74123 Taranto**

**Tel. 099 4725982
Cel. 329 7136075
E-mail: info@inoxlabtaranto.it**